

# MOS FET继电器 外形尺寸图·外观示例

## ■DIP4

(单位: mm)

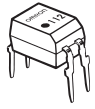

印刷基板用端子  
重量: 0.25g

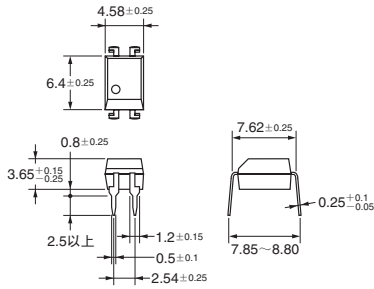

表面安装端子  
重量: 0.25g

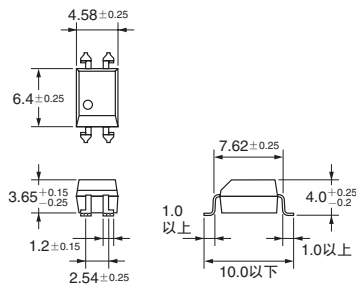

印刷基板加工尺寸(Bottom View)

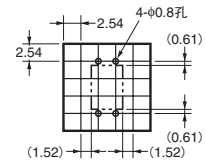

实际焊盘尺寸(推荐值)(TOP View)

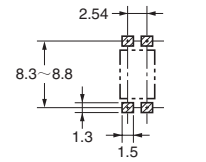

## ■DIP6

(单位: mm)

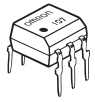

印刷基板用端子  
重量: 0.4g

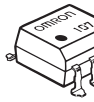
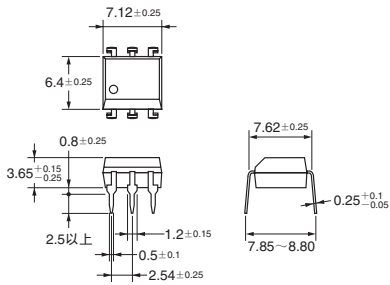

表面安装端子  
重量: 0.4g

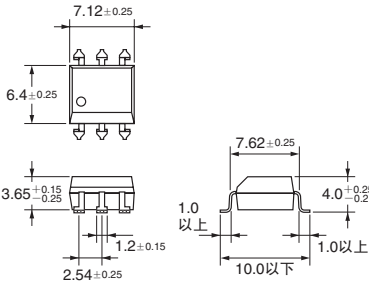

印刷基板加工尺寸(Bottom View)

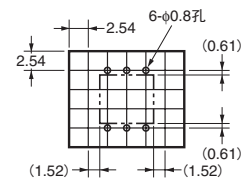

实际焊盘尺寸(推荐值)(TOP View)

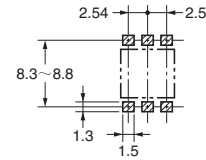

MOS FET继电器 外形尺寸图·外观示例

## ■DIP6(特殊)(G3VM-61BR/ER)

(单位: mm)

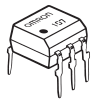

印刷基板用端子  
重量: 0.4g

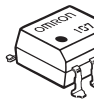
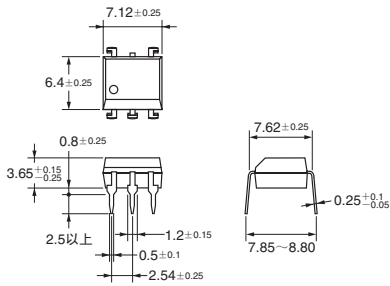

表面安装端子  
重量: 0.4g

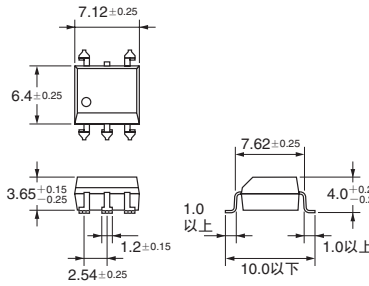

印刷基板加工尺寸(Bottom View)

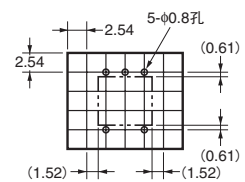

实际焊盘尺寸(推荐值)(TOP View)

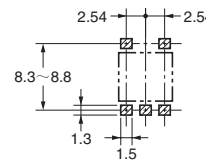

※ 标记内容与实际商品有所不同。

# MOS FET继电器 外形尺寸图·外观示例

## ■ DIP8

(单位: mm)



印刷基板用端子

重量: 0.54g

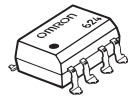
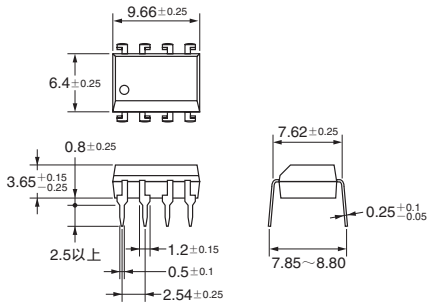

表面安装端子

重量: 0.54g

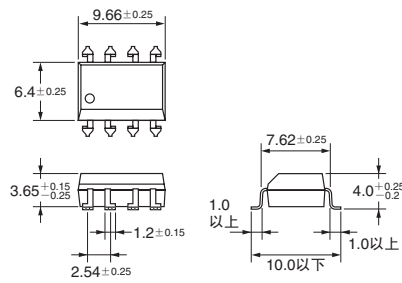

印刷基板加工尺寸(Bottom View)

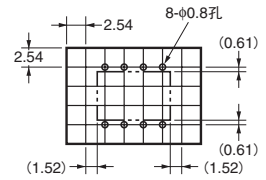

实际焊盘尺寸(推荐值)(TOP View)

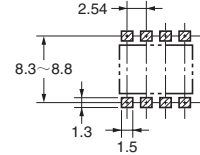

## ■ SOP4

(单位: mm)

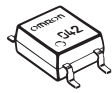

表面安装端子

重量: 0.1g

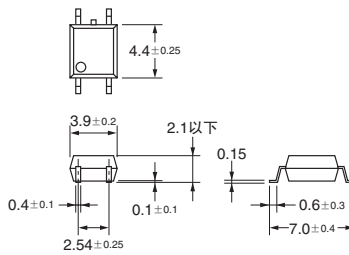

实际焊盘尺寸(推荐值)(TOP View)

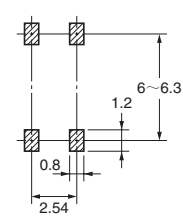

## ■ SOP4(特殊)(G3VM-61VY)

(单位: mm)

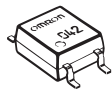

表面安装端子

重量: 0.1g

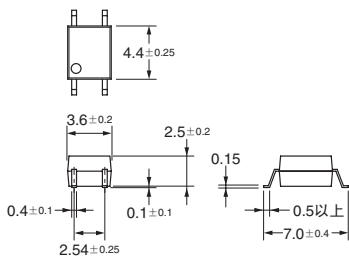

实际焊盘尺寸(推荐值)(TOP View)

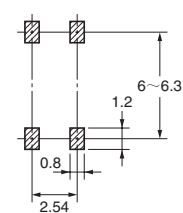

## ■ SOP6

(单位: mm)

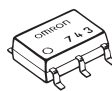

表面安装端子

重量: 0.13g

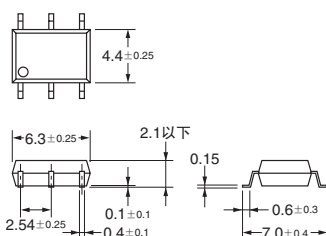

实际焊盘尺寸(推荐值)(TOP View)

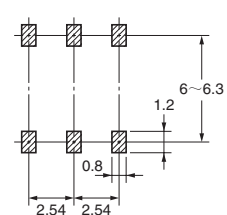

※ 标记内容与实际商品有所不同。

# MOS FET继电器 外形尺寸图·外观示例

## ■ SOP8

(单位: mm)

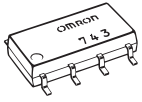

表面安装端子

重量: 0.2g

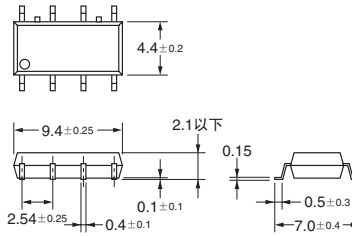

实际焊盘尺寸 (推荐值) (TOP View)

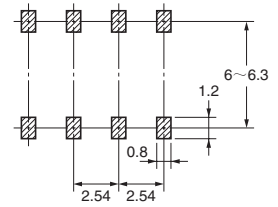

## ■ SSOP4

(单位: mm)

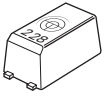

表面安装端子

重量: 0.03g

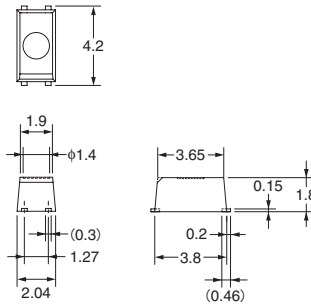

未指定尺寸公差为±0.1mm。

实际焊盘尺寸 (推荐值) (TOP View)

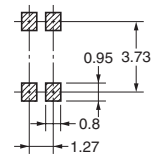

## ■ USOP4

(单位: mm)



表面安装端子

重量: 0.03g

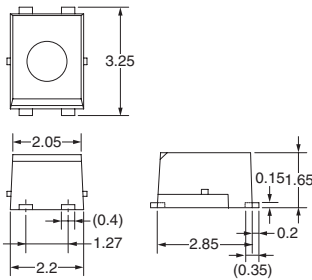

未指定尺寸公差为±0.2mm。

实际焊盘尺寸 (推荐值) (TOP View)

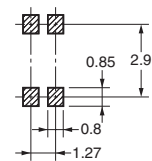

MOS FET继电器 外形尺寸图·外观示例

※ 标记内容与实际商品有所不同。

外观示例

DIP (Dual Inline Package)

DIP4脚

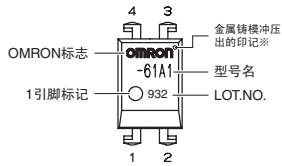

DIP6脚

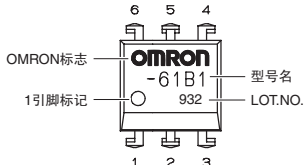

DIP6脚 (特殊)  
G3VM-61BR/ER

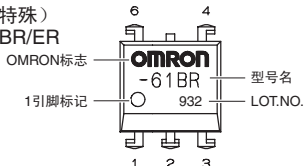

DIP8脚

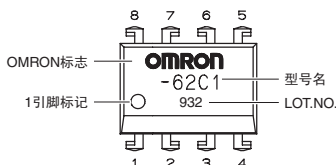

SOP (Small Outline Package)

SOP4脚

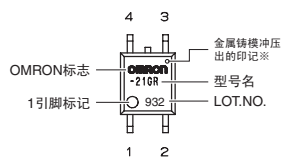

SOP4脚 (特殊)  
G3VM-61VY

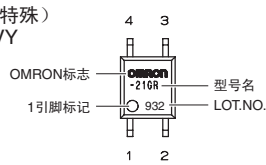

SOP6脚

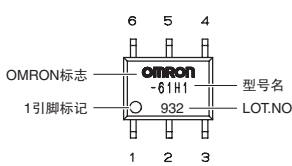

SOP8脚

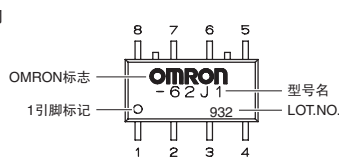

SSOP (Shrink Small Outline Package)

SSOP4脚

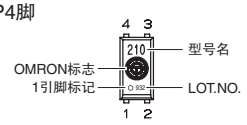

USOP (Ultra Small Outline Package)

USOP4脚

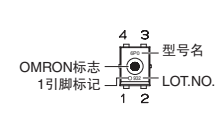

注. 产品的型号中没有标明“G3VM”。  
※1引脚标记和对角的凹痕是冲压模具冲压出的印记。