

B32

轻触式开关用开关头

B3F、B3FS、B3W的凸型 柱塞类型专用键顶

●有各种大小、形状、颜色等丰富的产品系列。

符合RoHS

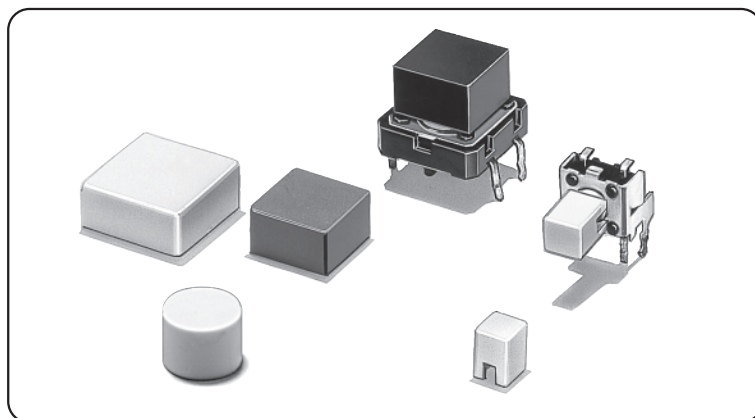

■种类

●B3F、B3FS、B3W专用

键顶颜色	键顶大小	6mm方形开关用 B3F-1000、-1000-G、-3000、-3000-G、-6000系列 B3W-1000系列 B3FS-1000系列			12mm方形开关用 B3F-4000、-5000、-5001系列、 B3W-4000系列 B3FS-4000系列		
		4×4mm	φ6mm圆型	D型	9×9mm	12×12mm	φ9.5mm
象牙色		B32-1000	B32-2000	B32-2100	B32-1200	B32-1300	B32-1600
黑		B32-1010	B32-2010	B32-2110	B32-1210	B32-1310	B32-1610
橙		B32-1020	—	—	B32-1220	B32-1320	B32-1620
黄		B32-1030	—	—	B32-1230	B32-1330	B32-1630
蓝		B32-1040	—	—	B32-1240	B32-1340	—
绿		B32-1050	—	—	B32-1250	B32-1350	—
白		B32-1060	—	—	B32-1260	B32-1360	—
红		B32-1080	—	—	B32-1280	B32-1380	—

注：最小包装单位为1,000个/袋。订购数量必须为最小包装单位的整数倍。

■性能

使用环境温度	-25~+70℃ 60%RH以下（无结冰、无凝露）
使用环境湿度	35~85%RH（+5~+35℃）

■外形尺寸（单位：mm）

B32-10□0

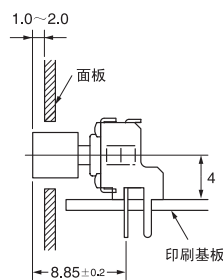
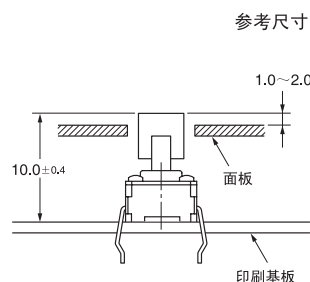
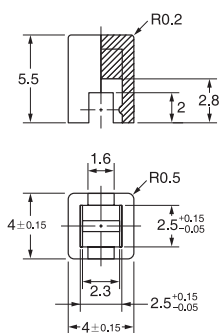

面板切割尺寸

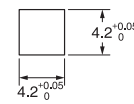

B32-2000
B32-2010

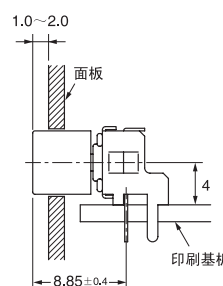
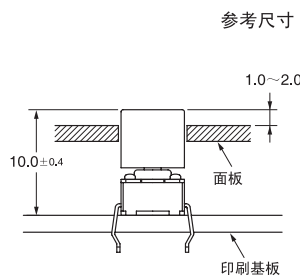
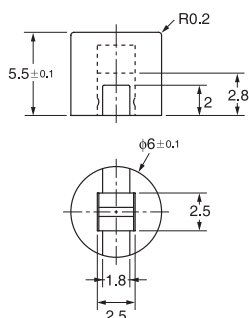

面板切割尺寸

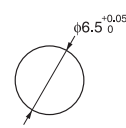

B32-2100
B32-2110

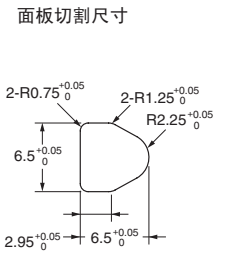
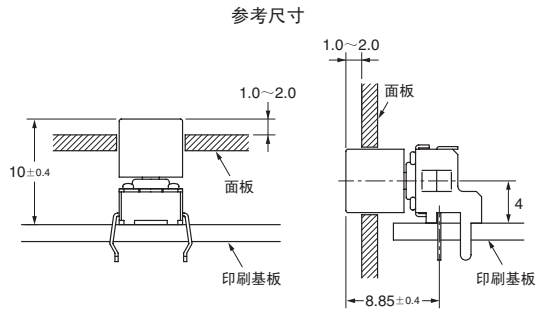
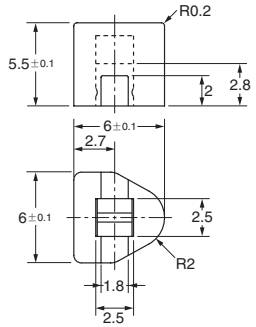

B32-12□0

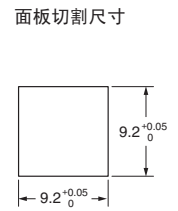
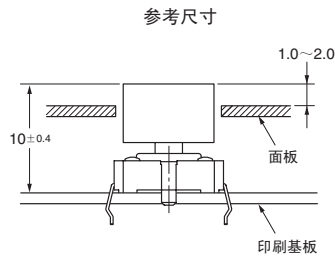
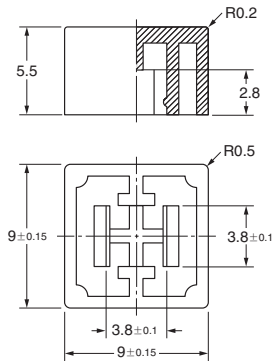

B32-13□0

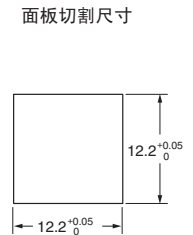
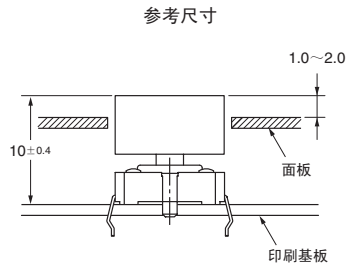
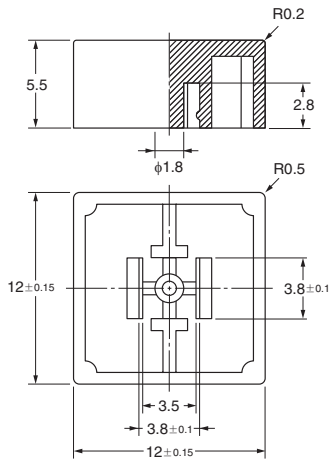

B32-16□0

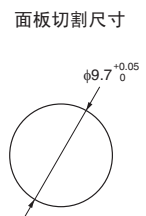
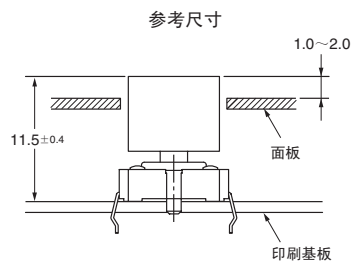
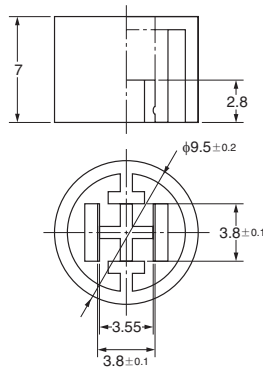

■请正确使用

注. 上述外形尺寸图中, 未注公差±0.4mm.

使用注意事项

●关于焊接工序

因为不能承受焊接工序中的热量, 请务必在焊接工序后再安装到开关上。

订购前请务必阅读我司网站上的“注意事项”。

欧姆龙电子部品(中国)统辖集团

网站

欧姆龙电子部品贸易(上海)有限公司

<https://www.ecb.omron.com.cn>

Cat. No. **A077-E1-CN-01** 2020年2月

© OMRON Corporation 2020 All Rights Reserved.
规格等随时可能更改,恕不另行通知。