

# Glossary

## ■ General Terms

### Basic Switch

A small-size switch with a very small contact gap and snap-action mechanism and with a contact structure that switches by a specified movement and specified force enclosed in a case with an actuator provided on the exterior of the case. (Basic switches are often referred to as merely "switches" in this catalog.)

### Switch with Contacts

A type of switch that achieves the switching function through the mechanical switching of contacts. Use as opposed to a semiconductor switch with switch characteristics.

### Contact Form

The structure of the electrical I/O circuits of contacts used according to the type of application. (Refer to *Contact Form* table later in this section.)

### Ratings

Value generally used as a reference for ensuring the characteristics and performance of switches, such as the rated current and rated voltage. Ratings are given assuming specific conditions (such as the type of load, current, voltage, and frequency).

### Resin Filled (Molded Terminal)

A terminal which is filled with resin after being connected to the internal circuit of the switch with a lead to eliminate exposed current-carrying metal parts and thereby to enhance the drip-proof properties of the switch.

## ■ Terms for Configuration and Structure

### Switch Configuration and Structure

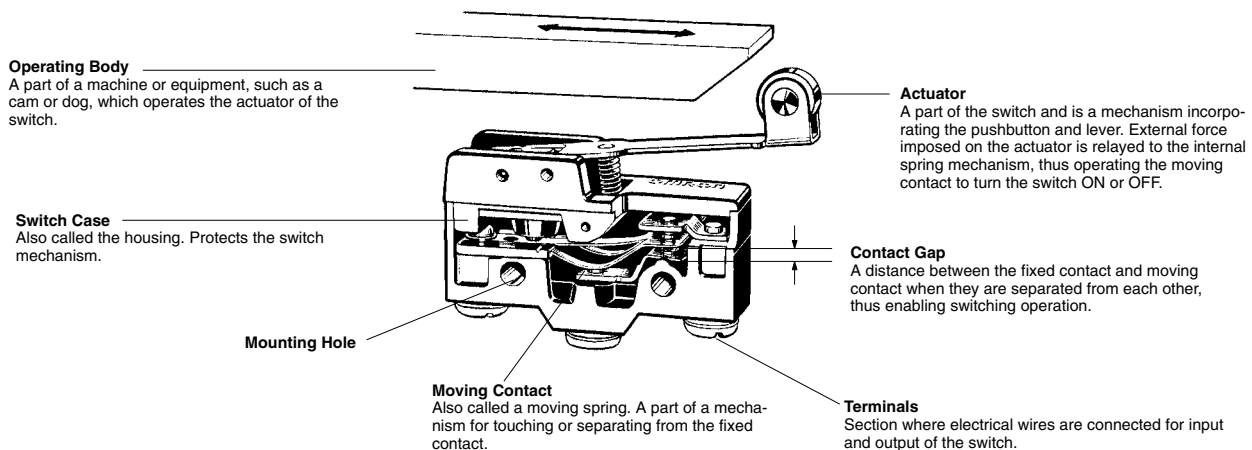

## ■ Terms Related to Durability

**Mechanical Durability:** The switching durability when a switch is operated at a specified frequency and specified overtravel (OT) without the contacts energized.

**Electrical Durability:** The switching durability when a switch is operated at a specified frequency and specified overtravel (OT) under the rated load.

## ■ Standard Test Conditions

Switches are tested under the following conditions.

- Ambient temperature: 20±2°C
- Relative humidity: 65±5%
- Atmospheric pressure: 101.3 kPa

### Insulation Resistance

The resistance between discontinuous terminals, between terminals and non-current-carrying metal parts, and between terminals and ground.

### Dielectric Strength

The threshold value up to which insulation will not be destroyed when a high voltage is applied for 1 minute to a predetermined measurement location.

### Contact Resistance

The electrical resistance of the contact point of contacts. Generally, the contact resistance includes the conductive resistance of the spring or terminal section.

### Vibration Resistance

**Malfunction:** The range of vibration for which closed contacts will not open for longer than a specific time when vibration is applied to a switch currently in operation.

### Shock Resistance

**Destruction:** The range of shock for which the components of the switch will not be damaged and for which operating characteristics are maintained when mechanical shock is applied to a switch during transportation or installation.



**Malfunction:** The range of shock for which closed contacts will not open for longer than a specific time when shock is applied to a switch currently in operation.

## ■ N-level Reference Value

The N-level reference value indicates the failure rate of the switch. The following formula indicates that the failure rate is 1/2,000,000 at a reliability level of 60% ( $\lambda_{60}$ ).

$$\lambda_{60} = 0.5 \times 10^{-6}/\text{operations}$$

■ Contact Shape and Type

Shape	Type	Main material	Processing method	Main application
	Crossbar contact	Gold alloy Silver alloy	Welding or riveting	Crossbar contacts are used for ensuring high contact reliability for switching micro loads. The moving contact and fixed contact come in contact with each other at a right angle. Crossbar contacts are made with materials that environment-resistant, such as gold alloy. In order to ensure excellent contact reliability, bifurcated crossbar contacts may be used.
	Needle	Silver		Needle contacts are used for ensuring improvement in contact reliability for switching loads, such as relays. A needle contact is made from a rivet contact by reducing the bending radius of the rivet contact to approximately 1 mm for the purpose of improving the contact pressure per unit area.
	Rivet	Silver Silver plated Silver alloy Gold plated		Rivet contacts are used in a wide application range from standard to high-capacity loads. The fixed rivet contact is usually processed so that it has a groove to eliminate compounds that may be generated as a result of switching. Furthermore, to prevent the oxidation or sulfidization of the silver contacts while the switch is stored, the contacts may be gold-plated. Contacts made with silver alloy are used for switching high current, such as the current supplied to TV sets.

■ Contact Gap

The contact gap is either 0.25, 0.5, 1.0, or 1.8 mm. The contact gap is a design goal. Check the contact gap of the switch to be used if a minimum contact gap is required. The standard contact gap is 0.5 mm. Even for the same switch configuration, the smaller the contact gap of a switch mechanism is, the less the movement differential (MD) is and the more sensitivity and longer durability the switch has. Such a switch cannot ensure, however, excellent switching performance, vibration resistance, or shock resistance.

A switch becomes less sensitive when the movement differential (MD) increases along with the contact gap due to the wear and tear of the contacts as a result of current switching operations. If a switch with a contact gap of 0.25 mm is used for its high sensitivity, it will be necessary to minimize the switching current in order to prevent the wear and tear of the contacts as a result of current switching operations. A switch with a wide contact gap excels in vibration resistance, shock resistance, and switching performance.

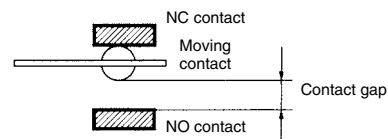

Character displayed	Contact gap	DC switching	MD	Accuracy and durability	Vibration and shock resistance	Feature
H	0.25 mm	Inferior	Minimal	Excellent	Inferior	High precision and long durability
G	0.50 mm	Ordinary	Short	Good	Ordinary	General-purpose
F	1.00 mm	Good	Medium	Ordinary	Good	Performance level between G and E
E	1.80 mm	Excellent	Long	Inferior	Excellent	Highly vibration and shock resistive

■ Terms Related to Operating Characteristics

Definitions of Operating Characteristics	Classification	Term	Abbreviation	Unit	Dispersion	Definition
	Force	Operating Force	OF	N {gf, kgf}	Max.	The force applied to the actuator required to operate the switch contacts from the free position to the operating position.
		Releasing Force	RF	N {gf, kgf}	Min.	The value to which the force on the actuator must be reduced to allow the contacts to return to the normal position.
		Total Travel Force	TTF	N {gf, kgf}	---	The force required for the actuator to reach the total travel position from the free position.
	Travel	Pretravel	PT	mm or degrees	Max.	The distance or angle through which the actuator moves from the free position to the operating position.
		Overtravel	OT	mm or degrees	Min.	The distance or angle of the actuator movement beyond the operating position to the total travel position.
		Movement Differential	MD	mm or degrees	Max.	The distance or angle of the actuator from the operating position to the releasing position.
		Total Travel	TT	mm or degrees	---	The distance or angle of the actuator movement from the free position to the total travel position.
	Position	Free Position	FP	mm or degrees	Max.	The initial position of the actuator when no external force is applied.
		Operating Position	OP	mm or degrees	±	The position of the actuator at which the contacts snap to the operated contact position when external force is applied from the free position.
		Releasing Position	RP	mm or degrees	---	The position of the actuator at which the contacts snap from the operated contact position to their free position.
		Total Travel Position	TTP	mm or degrees	---	The position of the actuator when it reaches the stopper.

Example of Fluctuation:

V-21-1□6 with max. operating force of 3.92 N

The above means that each switch sample operates with a maximum operating force (OF) of 3.92 N when increasing the OF imposed on the actuator from 0. Refer to page 28, *Operating Stroke Setting*.

■ Terminal Symbol and Contact Form

Contact	Terminal symbol
COM	Common terminal
NC	Normally closed terminal
NO	Normally open terminal

■ Terminal Types

Type	Shape
Solder terminal	
Quick-connect terminal (#110, #187, and #250)	
Screw terminal	
PCB terminal	
Angle terminal	

**Note:** In addition to the above, molded terminals with lead wires and snap-on mounting connectors are available.

■ Contact Form

Symbol	Name
	SPDT
	SPST-NC
	SPST-NO
	Split contacts Z-10FY-B
	Maintained contacts Z-15ER
	DPDT DZ

## ■ Terms Related to EN61058-1 Standards

**Electric Shock Protective Class:** Indicates the electric shock preventive level. The following classes are provided.

- Class 0: Electric shocks are prevented by basic insulation only.
- Class I: Electric shocks are prevented by basic insulation and grounding.
- Class II: Electric shocks are prevented by double insulation or enforced insulation with no grounding required.
- Class III: No countermeasures against electric shocks are required because the electric circuits in use operate in a low-enough voltage range (50 VAC max. or 70 VDC max.)

**Proof Tracking Index (PTI):** Indicates the index of tracking resistance, that is, the maximum dielectric strength with no short-circuiting between two electrodes attached to the switch sample while 50 drops of 0.1% ammonium chloride solution are dropped between the electrodes drop by drop. Five levels are provided. The following table indicates the relationship between these PTI levels and CTI values according to the UL Plastics Recognized Directory.

PTI	CTI Classified by UL
500	PLC level 1: $400 \leq CTI < 600$ (Check with material manufacturer if the material meets CTI 500)
375	PLC level 2: $250 \leq CTI < 400$ (Check with material manufacturer if the material meets CTI 375)
300	PLC level 2: $250 \leq CTI < 400$ (Check with material manufacturer if the material meets CTI 300)
250	PLC level 2: $250 \leq CTI < 400$
175	PLC level 3: $175 \leq CTI < 250$

**Number of Operations:** Indicates the operation number of durability test provided by the standard. They are classified into the following levels and the switch must bear the corresponding symbol. A switch with high switching frequency must withstand 50,000 switching operations and that with low switching frequency must withstand 10,000 operations to satisfy IEC standards.

Number of operations	Symbol
100,000	1E5
50,000	5E4
25,000	25E3
10,000	No symbol required
6,000	6E3
3,000	3E3
1,000	1E3
300	3E2

**Ambient Temperature:** Indicates the operating temperature range of the switch. The table indicates the meaning of symbol for reference.

<b>Symbol</b>	T85	25T85
<b>Temperature range</b>	0°C to 85°C	-25°C to 85°C

**Solder Terminal Type 1:** A type of solder terminal classified by heat resistance under the following test conditions.

**Dip soldering bath applied:** The terminal must not wobble or make any change in insulation distance after the terminal is dipped for a specified depth and period into a dip soldering bath at a temperature of 235°C at specified speed.

**Soldering iron applied:** The terminal must not wobble or make any change in insulation distance after the terminal is soldered by applying wire solder that is 0.8 mm in diameter for two to three

seconds by using a soldering iron, the tip temperature of which is 350°C.

**Solder Terminal Type 2:** A type of solder terminal classified by heat resistance under the following test conditions.

**Dip soldering bath applied:** The terminal must not wobble or make any change in insulation distance after the terminal is dipped for a specified depth and period into a dip soldering bath at a temperature of 260°C at specified speed.

**Soldering iron applied:** The terminal must not wobble or make any change in insulation distance after the terminal is soldered by applying wire solder that is 0.8 mm in diameter for 5 seconds by using a soldering iron, the tip temperature of which is 350°C.

**Clearance distance:** The minimum space distance between two charged parts or between a charged part and a metal foil stuck to the non-metal switch housing.

**Creepage distance:** The minimum distance on the surface of the insulator between two charged parts or between a charged part and a metal foil stuck to the non-metal switch housing.

**Distance through insulation:** The minimum direct distance between the charged part and a metal foil stuck to the insulative switch housing through air plus any other insulator thickness including the housing itself. The distance through insulation will be the insulator thickness when there is no distance through air.

## Cautions

**Note:** Always observe the following cautions to ensure safety.

### Mounting

Before mounting, dismounting, wiring, or inspecting a switch, be sure to turn OFF the power supply to the switch, otherwise an electric shock may be received or the switch may burn.

### Wiring

Do not perform wiring when power is being supplied to a switch. Also, do not touch any of the charged terminals when power is being supplied. Otherwise, electric shock may be received.

Follow the instructions provided in *Correct Use* for all wiring and soldering work. Using a switch with improper wiring or soldering may result in abnormal heating when power is supplied, possibly resulting in burning.

### Contact Load

Select suitable switch ratings after confirming contact load. If the contact load is excessive for the contacts, the contacts may weld or shift, possibly resulting in short-circuits or burning when power is supplied.

### Load Types

Some types of load have a large difference between steady-state current and inrush current, as shown in the following diagram. Select a switch with ratings suitable for the type of load. The higher the inrush current in the closed circuit is, the more the contact abrasion or shift there will be. Consequently, contact welding or shifting may occur, possibly resulting in short-circuits or burning.

#### Types of Load vs. Inrush Current

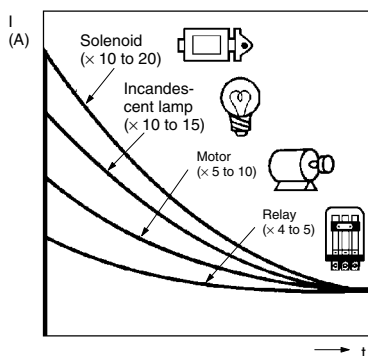

### Operating Atmosphere

Do not use switches in atmospheres containing combustible or explosive gases. Arc or heat generated by switching may cause fires or explosions.

### Shock on Individual Switches

Do not drop or disassemble switches. Not only will characteristics be jeopardized, but also damage, electric shock, or burning may result.

### Durability

The durability of a switch greatly varies with switching conditions. Before using a switch, be sure to test the switch under actual conditions in the actual application and to use the switch within the switching operations causing no problem. If a deteriorated switch is used continuously, insulation failures, contact welding, contact failures, switch damage, or switch burnout may result.

## Correct Use

No.	Area	No.	Item	Page
1	Using Switches			26
2	Selecting Correct Switch			
3	Electrical Conditions	1	Load	27
		2	Application of Switch to Electronic Circuits	
		3	Switches for Micro Loads	
		4	Contact Protective Circuit	
4	Mechanical Conditions	1	Operating Stroke Setting	28
		2	Switching Speed and Frequency	
		3	Operating Condition	
		4	Operating Method	
5	Mounting	1	Securing	29
		2	Terminal Connections	
		3	Soldering Precautions	
6	Operation and Storage Environment	1	Handling	30
		2	Operating Environment	
		3	Storage Environment	
7	Switch Trouble and Corrective Action			31

### ■ Using Switches

- When switches are actually used, unforeseen accidents may occur. Before using a switch, perform all possible testing in advance.
- Unless otherwise specified, ratings and performances given in this catalog are for standard test conditions (i.e., 15 to 35°C, 25% to 75% humidity, and 86 to 106 kPa atmospheric pressure). When performing testing in the actual application, always use the same conditions as will be used in actual usage conditions for both the load and the operating environment.
- Reference data provided in this catalog represents actual measurements from production samples in graph form. All reference data values are nominal.
- All ratings and performance values provided in this catalog are the results of a single test each rating and performance value therefore may not be met for composite conditions.

### ■ Selecting Correct Switch

Select an appropriate switch for the operating environment and load conditions.

- Use the *Selection Guide* to select a suitable switch for the rated current, operating load, actuator type, and operating environment.
- It is not recommended to use a switch for a large current to switch a micro current, in terms of contact reliability. Select a switch that is suitable for the current actually being switched.
- Use a sealed switch in environments subject to water, other liquids and excessive dirt or dust.

### ■ Electrical Conditions

#### Load

The switching capacity of a switch significantly differs depending on whether the switch is used to break an alternating current or a direct current. Be sure to check both the AC and DC ratings of a switch. The control capacity will drop drastically if it is a DC load. This is because a DC load, unlike an AC load, has no current zero cross point. Therefore, if an arc is generated, it may continue for a comparatively long time. Furthermore, the current direction is always the same, which results in contact relocation phenomena, and the contacts hold each other with ease and will not separate if the surfaces of the contacts are uneven.

If the load is inductive, counter-electromotive voltage will be generated. The higher the voltage is, the higher the generated energy is, which increase the abrasion of the contacts and contact relocation phenomena. Make sure to use a switch within the rated conditions.

If a switch is used for switching both micro and high-capacity loads, be sure to connect relays suitable to the loads.

The rated loads of a switch are according to the following conditions:

**Inductive Load:** A load having a minimum power factor of 0.4 (AC) or a maximum time constant of 7 ms (DC).

**Lamp Load:** A load having an inrush current ten times the steady-state current.

**Motor Load:** A load having an inrush current six times the steady-state current.

**Note:** It is important to know the time constant (L/R) of an inductive load in a DC circuit.

#### Inrush Current

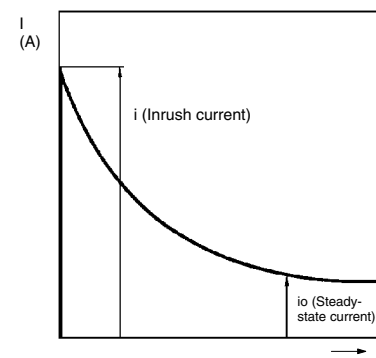

#### Application of Switch to Electronic Circuits

The Basic switch may have contact bouncing or chattering in switching, thus generating noise or pulse signals that may interfere the operation of electronic circuits or audio equipment. To prevent this, take the following countermeasures.

- Design the circuits so that they include appropriate CR circuits to absorb noise or pulse signals.
- Use switches with gold-plated contacts for micro loads, which are more resistive to environmental conditions.

#### Switches for Micro Loads

If a switch for a general load is used for switching a micro load, it may cause contact failures. Be sure to select a switch within the permissible range. Even if a switch for a micro load is used within the permissible range, the inrush current of the load may deteriorate the contacts, thus decreasing the durability of the switch. Therefore, if necessary, insert a proper contact protective circuit.

**Contact Protective Circuit**

Apply a contact protective circuit (surge killer) to extend contact durability, prevent noise, and suppress the generation of carbide or nitric acid due to arc. Be sure to apply the contact protective circuit properly, otherwise an adverse effect may result. Some typical examples of contact protective circuit are described in the following table.

When a switch is used under high humidity, arcs resulting from certain types of load (e.g., inductive loads) will generate nitrous oxides and, with mater the nitrous oxides will become nitric acid, which will corrode internal metal parts and may cause malfunctions. Always use a contact protective circuit according to information provided in the following table when using a switch under circuit conditions of frequent switching and arcing.

The use of a contact protective circuit may delay the response time of the load.

**Typical Examples of Contact Protective Circuits (Surge Killers)**

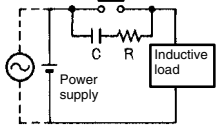
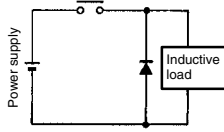
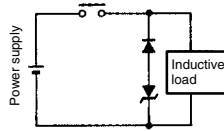
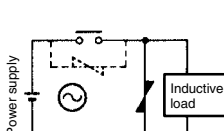
Circuit example	Applicable current		Feature	Element selection
	AC	DC		
CR circuit 	See note.	Yes	<b>Note:</b> When AC is switched, the load impedance must be lower than the C and R impedance.  The operating time will increase if the load is a relay or solenoid. It is effective to connect the CR circuit in parallel to the load when the power supply voltage is 24 or 48 V and in parallel to the contacts when the power supply voltage is 100 to 200 V.	C: 0.5 to 1 $\mu$ F per switching current (1 A) R: 0.5 to 1 $\Omega$ per switching voltage (1 V) The values may change according to the characteristics of the load.  The capacitor suppresses the spark discharge of current when the contacts are open. The resistor limits the inrush current when the contacts are closed again. Consider these roles of the capacitor and resistor and determine the ideal capacitance and resistance values from experimentation. Use a capacitor with a dielectric strength between 200 and 300 V. When AC is switched, make sure that the capacitor has no polarity. If, however, the ability to control arcs between contacts is a problem for high DC voltage, it may be more effective to connect a capacitor and resistor between the contacts across the load. Check the results by testing in the actual application.
	Yes	Yes		
Diode method 	No	Yes	Energy stored in the coil is changed into current by the diode connected in parallel to the load. Then the current flowing to the coil is consumed and Joule heat is generated by the resistance of the inductive load. The reset time delay in this method is longer than that of the CR method.	The diode must withstand a peak inverse voltage 10 times higher than the circuit voltage and a forward current as high as or higher than the load current.
Diode and Zener diode method 	No	Yes	This method will be effective if the reset time delay caused by the diode method is too long.	Zener voltage for a Zener diode must be about 1.2 times higher than the power source since the load may not work under some circumstances.
Varistor method 	Yes	Yes	This method makes use of constant-voltage characteristic of the varistor so that no high-voltage is imposed on the contacts. This method causes a reset time delay more or less. It is effective to connect varistor in parallel to the load when the supply voltage is 24 to 48 V and in parallel to the contacts when the supply voltage is 100 to 200 V.	Select the varistor so that the following condition is met for the cut voltage $V_c$ . For AC currents, the value must be multiplied by $\sqrt{2}$ . $V_c > (\text{Current Voltage} \times 1.5)$ If $V_c$ is set too high, however, the voltage cut for high voltages will no longer be effective, diminishing the effect.

Do not apply contact protective circuit as shown below.

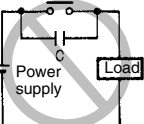
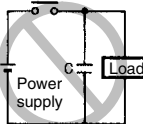
<b>Incorrect</b> 	This circuit effectively suppresses arcs when the contacts are OFF. The capacitance will be charged, however, when the contacts are OFF. Consequently, when the contacts are ON again, short-circuited current from the capacitance may cause contact weld.	<b>Incorrect</b> 	This circuit effectively suppresses arcs when the contacts are OFF. When the contacts are ON again, however, charge current flows to the capacitor, which may result in contact weld.
---	---	---	---

**■ Mechanical Conditions**

**Operating Stroke Setting**

The setting of stroke is very important for a switch to operate with high reliability.

The chart below shows the relationship among operating force, stroke, and contact force. To obtain high reliability from a switch, a switch actuator must be manipulated within an appropriate range of operating force.

Be sure to pay the utmost attention when mounting a switch.

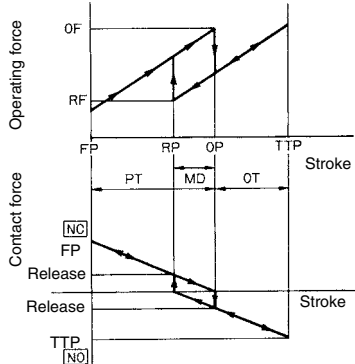

Make sure that the operating body is set so that the actuator should return to the free position when the operating body has moved if a switch is used to form a normally closed (NC) circuit. If a switch is used to form a normally open (NO) circuit, the operating body must move the switch actuator to the distance of 70% to 100% of the rated overtravel (OT) of the switch.

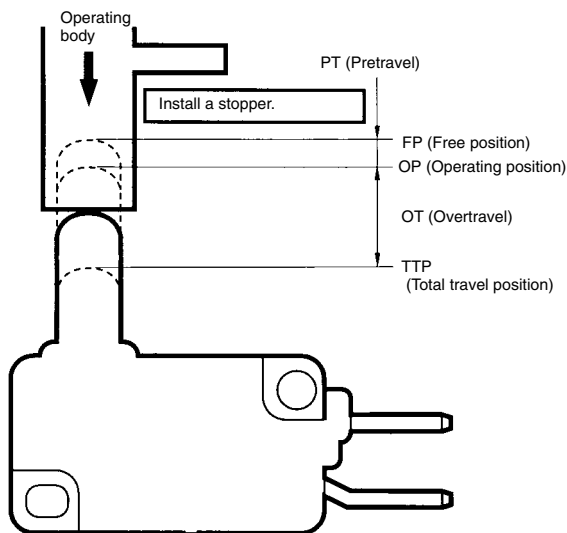

If stroke is set in the vicinity of the operating position (OP) or the releasing position (RP), contact force may become unstable. As a result, the switch cannot ensure high reliability. Furthermore, the switch may malfunction due to vibration or shock.

If stroke is set exceeding the total travel position (TTP), the moment of inertia of the operating body may damage the actuator or the switch itself, and the stress applied to the moving spring inside the switch will increase and then, the durability of the switch may be deteriorated.

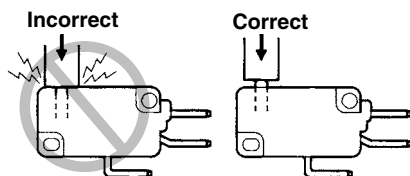

**Switching Speed and Frequency**

The switching frequency and speed of a switch have a great influence on the performance of the switch. Pay attention to the following.

- If the actuator is operated too slowly, the switching operation may become unstable, causing contact failures or contact welding.
- If the actuator is operated too quickly, the switch may be damaged by shock.
- If the switching frequency is too high, the switching of the contacts cannot catch up with the operating speed of the actuator.
- If the operating frequency is extremely low (i.e., once a month or less frequent), a film may be generated on the surface of the contacts, which may cause contact failures.

The permissible switching speed and switching frequency of a switch indicate the operational reliability of the switch. The durability of a switch is based on operation under specific conditions regarding the switching speed and switching frequency. The durability of a switch may not meet the durability due to conditions even if the switch is operated within the permissible switching speed and frequency ranges. Test a switch sample under the actual conditions to ascertain its durability.

**Operating Condition**

Do not leave a switch with the actuator depressed for a long time, otherwise the parts of the switch may soon deteriorate and the changes of its characteristics operating may result.

**Operating Method**

The operating method has a great influence on the performance of a switch. Consider the following before operating a switch.

- Design the operating body (i.e., cam or dog) so that it will operate the actuator smoothly. If the actuator snaps backwards quickly or receives shock due to the shape of the operating body, its durability may be deteriorated.

**Incorrect**

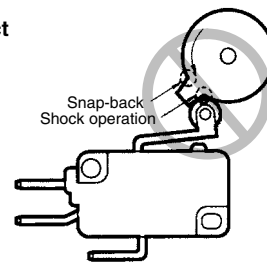

**Correct**

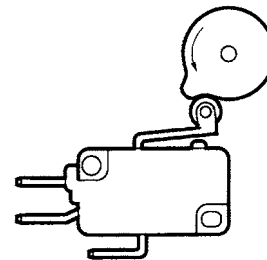



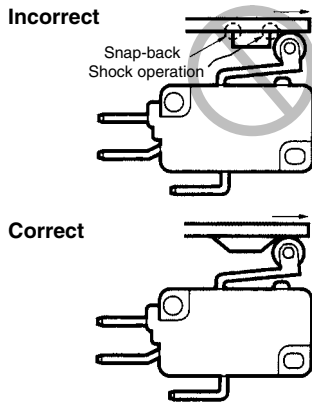

- Make sure that no improper force is applied to the actuator, otherwise the actuator may incur local abrasion. As a result, the actuator may become damaged or its durability may be deteriorated.

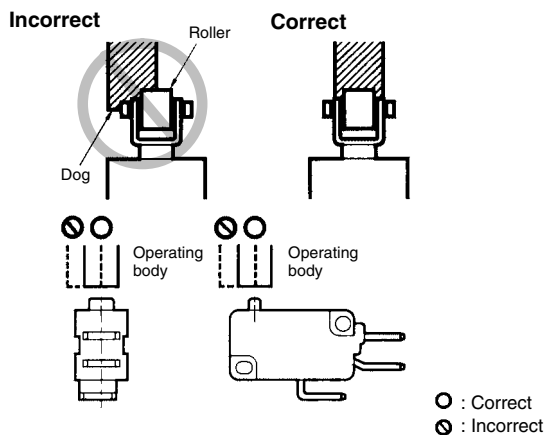

- Make sure that the operating body moves in a direction where the actuator moves. If the actuator is a pin plunger type, make sure that the operating body presses the pin plunger vertically.
- Operate the actuator of a hinge roller lever or simulated hinge lever type in the direction shown below.

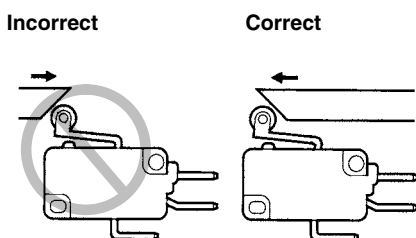

- Set the angle of the cam or dog ( $\theta$ ) for roller levers and similar actuators to the range between  $30^\circ$  and  $45^\circ$ . If the angle is too large, an abnormally large horizontal stress will be applied to the lever.

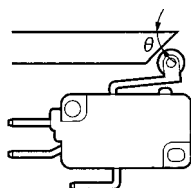

- Do not modify the actuator. If the actuator is modified, excessive external force may be applied to the internal switch mechanism, characteristics may change, and the switch may stop functioning.
- If an external actuator is used as an operating object, check the material and thickness of the lever to make sure that the force applied to the lever is within the permissible range.

■ Mounting

Securing

When mounting a switch, be sure to use the specified mounting screws and tighten the screws with flat washers or spring washers securely.

However, the switch housing may incur crack damage if it comes into contact with the spring washers directly. In that case make sure that the flat washers come into contact with the switch housing as shown below. Do not subject the switch to excessive shock or high-frequency vibrations when mounting (e.g., do not use an impact driver) as it may cause contacts stick or switch damage.

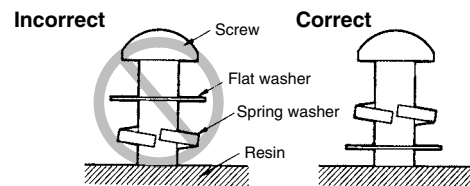

Do not modify the switch in any way, for example, by widening the mounting holes.

Locking Agent

If glue or locking agent is applied, make sure that it does not stick to the moving parts or intrude into the inside of the switch, otherwise the switch may have operating failure or contact failure. Some types of glue or locking agent may generate gas that has a bad influence on the switch. Pay the utmost attention when selecting glue or locking agent.

Wiring

Make sure that the lead wires are connected with no inappropriate pulling force.

Mounting Location

Be sure not to mount a switch in locations where the switch may be actuated by mistake.

Maintenance and Inspection

Make sure that a switch is mounted in locations that allow easy inspection or replacement of the switch.

Mounting Direction

When using a switch with a low operating force mounted with a long lever, make sure that the switch is mounted in the direction where the weight of the lever is not applied to the pushbutton directly, otherwise the switch may have releasing failures.

Terminal Connections

Solder Terminals

When soldering lead wires to a switch, make sure that the temperature of the iron tip is  $380^\circ\text{C}$  maximum. Improper soldering may cause abnormal heat radiation from the switch and the switch may burn.

Complete soldering within 5 seconds at  $350^\circ\text{C}$  or within 3 seconds at  $380^\circ\text{C}$ . If heat is applied for longer period of time, switch characteristics will be deteriorated, e.g., the case will melt and lead wire insulation will scorch.

Soldering conditions are even more strict for ultra subminiature switches. Refer to the *Precautions* for individual models for details.

Quick-Connect Terminals

Use the specified receptacles to connect to quick-connect terminals. Do not apply excessive force horizontally or vertically to the

terminals, otherwise the terminal may be deformed or the housing may be damaged.

**Wiring Work**

When wiring a switch, check the insulation distance between the switch and the mounting plate. If the insulation distance is insufficient, use an insulation guard or separator. Be particularly careful when mounting a switch to metal.

Use wire sizes suitable for the applied voltage and carrying current. Do not wire a switch while power is being supplied.

**Using Separators**

If providing sufficient insulation distance is a problem or there are metal components or copper wire near a switch, use a switch with an insulation guard or use a separator (order separately) to provide sufficient insulation distance.

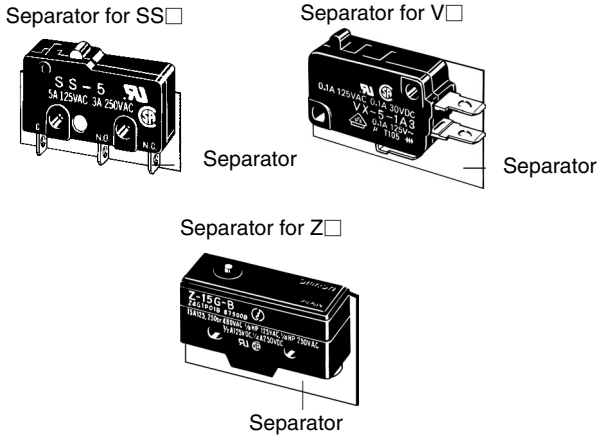

**Soldering Precautions**

When soldering by hand, place the terminal horizontal to the ground, use a soldering iron with a suitable heat capacity and a suitable amount of solder, and complete soldering quickly. Prevent flux from entering a switch by exhausting flux gas with an exhaust fan and by avoiding the contact of the tip of the soldering iron and the switch body. Flux gas inside a switch may cause contact failure. Do not apply any force to the terminal or wire immediately after soldering.

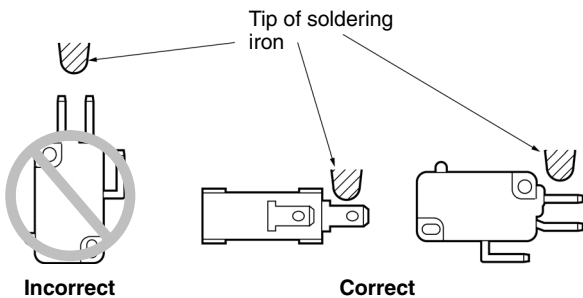

When soldering automatically, adjust the amount of solder so that flux does not float onto the top of PCB. If flux enters the switch, it can cause contact failure.

**Operation and Storage Environment Handling**

Do not apply oil, grease, or other lubricants to the sliding parts of a switch. The intrusion of oil, grease, or other lubricants into the internal part may cause operating failure or contact failure.

**Operating Environment**

A general switch is not water-resistant. Protect the switch appropriately when using the switch in places with water or oil spray.

Do not use a switch under the condition where vibration or shock is continuously applied to the switch. If continuous vibration or shock is applied to a switch, contact failure, malfunction, or decrease in durability may be caused by abrasive powder generated from the internal parts. If excessive vibration or shock is applied to a switch, the contacts may malfunction, stick, or be damaged.

Mount a switch in the location where vibration and shock is not applied to the switch and in the direction where they do not resonate.

Do not use a switch in the atmosphere of corrosive gas, such as sulfuric gas (H<sub>2</sub>S or SO<sub>2</sub>), ammonium gas (NH<sub>3</sub>), nitric gas (HNO<sub>3</sub>), or chlorine gas (Cl<sub>2</sub>), or in the atmosphere of high temperature and humidity. Otherwise, contact failure or corrosion damage may result.

If a switch is used in the atmosphere of silicon gas, arc energy may attract silicon dioxide (SiO<sub>2</sub>) to the contacts and contact failure may result. If there is silicon oil, silicon sealant, a wire covered with silicon, or any other silicon-based product near the switch, attach a contact protective circuit to suppress the arcing of the switch or eliminate the source of silicon gas generation. Even for a sealed switch, it may not be possible to prevent all of the gas from penetrating the seal rubber, and contact failure may result.

Be sure to use a switch at a temperature and humidity within the specified ranges. If a switch is exposed to radical temperature changes or intense heat, the characteristics of the switch may change. Separate the switch as far as possible from sources of heat to eliminate the influence.

**Storage Environment**

When storing a switch, consider countermeasures (e.g., storing in a plastic bag) to prevent discoloration resulting from sulfidization of terminals (silver-plated). Make sure that the location is free of corrosive gas or dust with no high temperature or humidity. It is recommended that a switch be inspected before use if it is stored for three months or more after the production, depending on the location.

## Switch Trouble and Corrective Action

Type	Location of failure	Failure	Possible cause	Corrective action
Failures related to electrical characteristics	Contact	Contact failure	Dust and dirt on the contacts.	Remove the cause of the problem, place the switch in a box, or use a sealed switch.
			Water or other liquid has penetrated into a switch.	
			Chemical substances have been generated on the contact surface due to the atmosphere containing chemical corrosive gas.	Use a switch having contacts with high environmental resistivity (such as gold or alloy contacts).
			Chemical substances have been generated on the contact surface when the switch switches a very low load.	
			Solder flux has penetrated into the switch.	Review the soldering method or use a sealed or flux-tight switch.
		Silicon gas exists near the switch.	Remove the material generating gas, or adjust contact capacity to prevent formation of silicon compounds on the contacts.	
	Malfunction	The contacts are separated from each other by vibration or shock.	Use a switch having a high contact force (generally a high OF).	
	Contact welding	The load connected to the switch is too high.	Switch the load with a high-capacity relay or magnetic relay or insert a contact protection circuit.	
	Insulation degradation (burning)	Contacts have been melted and scattered by arc.	Switch the load with a high-capacity relay or magnetic relay.	
		Water has penetrated into the switch because the switch has been used in an extremely hot environment.	Remove the cause of the problem, place the switch in a box, or use a sealed switch.	
Liquid has penetrated into the switch and been carbonized by arc heat.				
Failures related to mechanical characteristics	Actuator	Operating failure	The sliding part of the actuator has been damaged because an excessive force was applied on the actuator.	Make sure that no excessive force is applied to the actuator, or use an auxiliary actuator mechanically strong.
			Foreign material like dust, dirt and oil has penetrated into the switch.	Remove the cause of the problem or place the switch in a box.
			The actuator does not release because the operating body is too heavy.	Use a switch having a higher OF.
			The switch is loosely installed and thus does not operate even when the actuator is at the rated OP.	Secure the switch.
		Low durability	The shape of the dog or cam is improper.	Change the design of the dog or cam.
			The operating method is improper. The operating speed is too high.	Review the operating stroke and operating speed.
		Damage	A shock has been applied to the actuator.	Remove the cause of problem or use a switch mechanically strong.
	The caulked part is not good enough or the assembled condition is poor.		Replace the switch with a new one.	
	Deformation or drop-out Actuator was subjected to an excessive force and force from an inappropriate direction.		Review the handling and operating method.	
	Mounting section	Damage	Screws have not been inserted straight.	Check and correct screw insertion method.
			The mounting screws were tightened with too much torque.	Tighten the screws with an appropriate torque.
			The mounting pitch is wrong.	Correct the pitch.
			The switch is not installed on a flat surface.	Install the switch on a flat surface.
	Terminal	Damage	An excessive force was applied to the terminal while being wired.	Do not apply an excessive force.
			The plastic part has been deformed by soldering heat.	Reduce the soldering time or soldering temperature. (Refer to the information given under <i>Precautions</i> for that model.)