

Surface-mounting, 1-GHz-Band/3-GHz-Band, Miniature, DPDT, High-frequency Relay

- Superior high-frequency characteristics (at 1 GHz), such as an isolation of 20 dB min. between contacts of the same polarity or 30 dB min. between contacts of different polarity with an insertion loss of 0.2 dB max.
- Miniaturized to 10.3 × 6.9 × 5.4 mm (L × W × H).
- Rated power consumption of 100 mW with high sensitivity.
- Single-side stable and single-winding latching models available.
- Models with a smaller footprint (G6K(U)-2F-RF-S) are available to help save space.
- New G6K(U)-2F-RF-T models for 3-GHz band join the lineup with a downsized footprint.

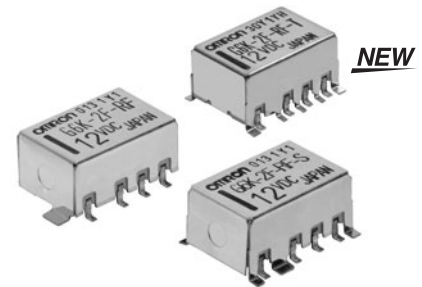

RoHS Compliant

Ordering Information

Model Number Legend:

G6K□-□□-□□-□□

1 2 3 4 5

- | | | |
|---|---|---|
| <p>1. Relay Function
None: Single-side stable
U: Single-winding latching</p> <p>2. Contact Form
2: DPDT</p> | <p>3. Terminal Shape
F: Surface-mounting terminals</p> <p>4. Special Function
RF: High-frequency compatible</p> | <p>5. Ground Terminal Shape
None: Standard
S: Small footprint
T: Compatible with 3 GHz</p> |
|---|---|---|

List of Models

Standard Models with Surface-mounting Terminals

Classification	Structure	Contact form	Rated coil voltage	Model	Minimum quantity packaged (See note.)
Single-side stable	Plastic sealed	DPDT	3, 4.5, 5, 12, and 24 VDC	G6K-2F-RF(-S)	300 Units/tray
Single-winding latching			3, 4.5, 5, 12, and 24 VDC	G6KU-2F-RF(-S)	300 or 900 Units/reel

Compatible with 3 GHz

Classification	Structure	Contact form	Rated coil voltage	Model	Minimum quantity packaged
Single-side stable	Plastic sealed	DPDT	3, 4.5, 5, 12, and 24 VDC	G6K-2F-RF-T	300 Units/tray
Single-winding latching			3, 4.5, 5, 12, and 24 VDC	G6KU-2F-RF-T	300 or 900 Units/reel

Note: When ordering Relays in tape packing, add “-TR03” or “-TR09” to the end of the model number. If “-TR” is not added, the Relays will be provided in tray packing.
Relays per reel: 300 for “-TR03”
900 for “-TR09”

This specification, however, is not part of the relay model number, so it is not marked on the relay case.

Application Examples

- Measurement equipment
- Communications equipment
- Broadcasting and audio-visual equipment
- Medical equipment

Specifications

■ Contact Ratings

Load	Resistive load
Rated load	125 VAC, 0.3 A 30 VDC, 1 A 1 GHz, 1 W (See note.)
Rated carry current	1 A
Max. switching voltage	125 VAC or 60 VDC
Max. switching current	1 A

Note: This value is for a V.SWR of 1.2 max. at the load.

■ High-frequency Characteristics (See note 3.)

Item	Type Frequency	G6K(U)-2F-RF(-S, -T)	G6K(U)-2F-RF-T
		1 GHz	3 GHz
Isolation	Between contacts of the same polarity	20 dB min.	18 dB min.
	Between contacts of different polarity	30 dB min.	25 dB min.
Insertion loss		0.2 dB max.	0.6 dB max.
V.SWR		1.2 max.	1.4 max.
Maximum carry power		3 W (See note 4.)	
Maximum switching power		1 W (See note 4.)	

- Note:**
1. The impedance of the measurement system is 50 Ω .
 2. The above values are initial values.
 3. Contact your OMRON representative if the Relay will be used in an application that requires high repeatability in high-frequency characteristics for the microload region. (Such applications include testing and measurement equipment and ATE applications.)
 4. These values are for a V.SWR of 1.2 max. at the load.

■ Characteristics

Item	Single-side stable models	Single-winding latching models
	G6K-2F-RF(-S, -T)	G6KU-2F-RF(-S, -T)
Contact resistance (See note 2.)	100 m Ω max.	
Operating (set) time (See note 3.)	3 ms max. (approx. 1.4 ms)	3 ms max. (approx. 1.2 ms)
Release (reset) time (See note 3.)	3 ms max. (approx. 1.3 ms)	3 ms max. (approx. 1.2 ms)
Minimum set/reset pulse time	---	10 ms
Insulation resistance (See note 4.)	1,000 M Ω min. (at 500 VDC)	
Dielectric strength	Between coil and contacts	750 VAC, 50/60 Hz for 1 min
	Between contacts of different polarity	750 VAC, 50/60 Hz for 1 min
	Between contacts of the same polarity	750 VAC, 50/60 Hz for 1 min
	Between ground and coil/contacts	500 VAC, 50/60 Hz for 1 min
Vibration resistance	Destruction: 10 to 55 to 10 Hz, 2.5-mm single amplitude (5-mm double amplitude) and 55 to 500 to 55 Hz, 300 m/s ² Malfunction: 10 to 55 to 10 Hz, 1.65-mm single amplitude (3.3-mm double amplitude) and 55 to 500 to 55 Hz, 200 m/s ²	
Shock resistance	Destruction: 1,000 m/s ² Malfunction: 750 m/s ²	
Endurance	Mechanical: 50,000,000 operations min. (at a switching frequency of 36,000 operations/hour) Electrical: 100,000 operations min. (at a switching frequency of 1,800 operations/hour)	
Ambient temperature	Operating: -40°C to 70°C (with no icing or condensation)	
Ambient humidity	Operating: 5% to 85%	
Weight	Approx. 0.95 g	

- Note:**
1. The above values are initial values.
 2. The contact resistance was measured with 10 mA at 1 VDC with a voltage drop method.
 3. Values in parentheses are actual values.
 4. The insulation resistance was measured with a 500-VDC megohmmeter applied to the same parts as those used for checking the dielectric strength.

■ Coil Ratings

Single-side Stable Models

G6K-2F-RF(-S, -T)

Rated voltage (VDC)	3	4.5	5	12	24
Rated current (mA)	33.0	23.2	21.1	9.1	4.6
Coil resistance (Ω)	91	194	237	1,315	5,220
Must operate voltage (V)	80% max. of rated voltage				
Must release voltage (V)	10% min. of rated voltage				
Maximum voltage (V)	150% of rated voltage				
Power consumption (mW)	Approx. 100 mW				

Single-winding Latching Models

G6KU-2F-RF(-S, -T)

Rated voltage (VDC)	3	4.5	5	12	24
Rated current (mA)	33.0	23.2	21.1	9.1	4.6
Coil resistance (Ω)	91	194	237	1,315	5,220
Must operate voltage (V)	75% max. of rated voltage				
Must release voltage (V)	75% max. of rated voltage				
Maximum voltage (V)	150% of rated voltage				
Power consumption (mW)	Approx. 100 mW				

- Note:**
1. The rated current and coil resistance are measured at a coil temperature of 23°C with a tolerance of $\pm 10\%$.
 2. The operating characteristics are measured at a coil temperature of 23°C.
 3. The maximum voltage is the highest voltage that can be imposed on the Relay coil instantaneously.

Engineering Data

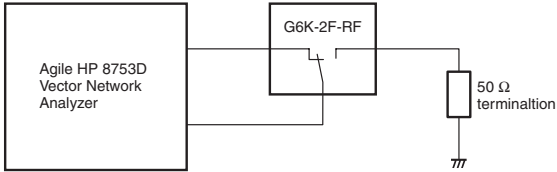

High-frequency Characteristics (Isolation)

G6K-2F-RF

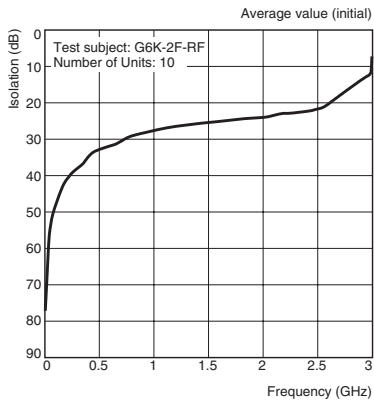

High-frequency Characteristics (Insertion Loss)

G6K-2F-RF

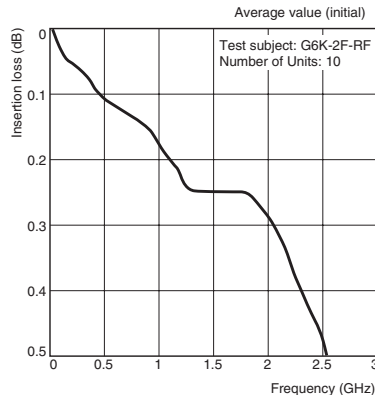

High-frequency Characteristics (Return Loss, V.SWR)

G6K-2F-RF

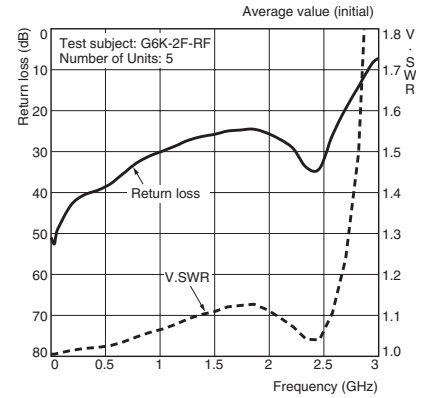

G6K-2F-RF-S

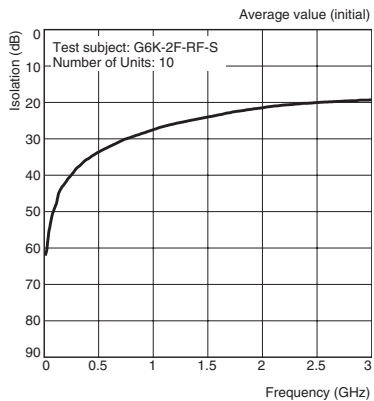

G6K-2F-RF-S

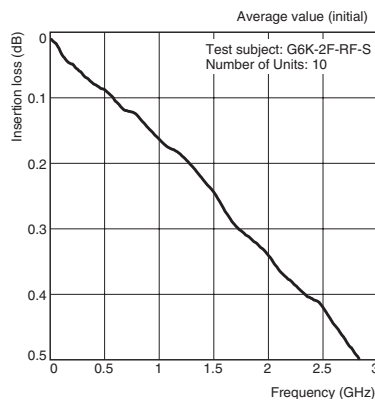

G6K-2F-RF-S

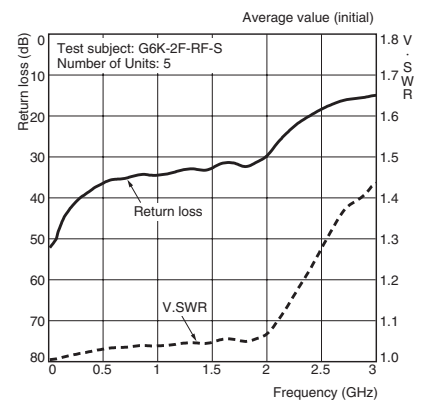

G6K-2F-RF-T

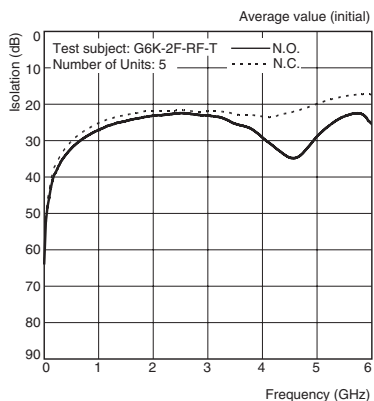

G6K-2F-RF-T

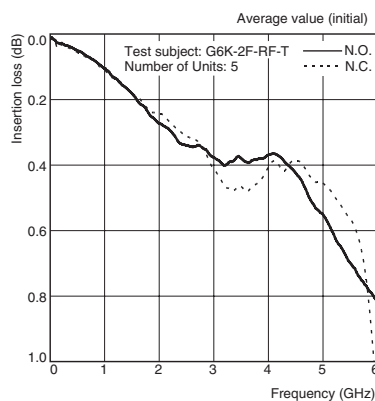

G6K-2F-RF-T

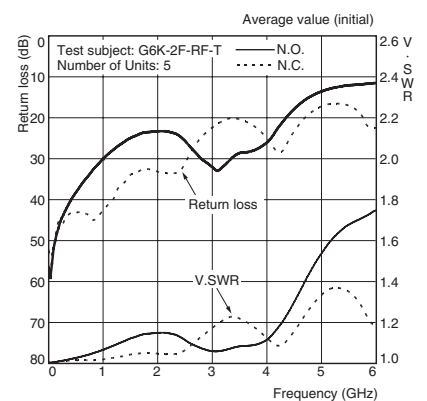

- Note:**
1. Refer to the G6K specifications for basic specifications not shown above.
 2. Ambient temperature condition: 23°C
 3. The high-frequency characteristics depend on the mounting board. Be sure to check operation including durability in actual equipment before use.

Dimensions

Note: All units are in millimeters unless otherwise indicated.

G6K-2F-RF
G6KU-2F-RF

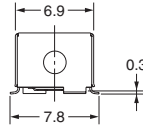
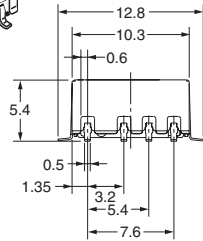
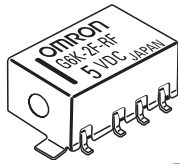

Mounting Dimensions (Top View)
Tolerance: ± 0.1 mm

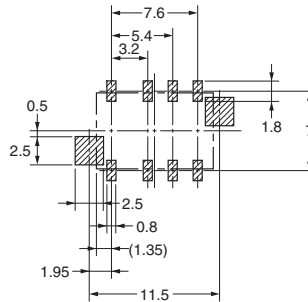

Terminal Arrangement/Internal Connections (Top View)

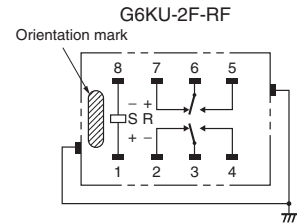
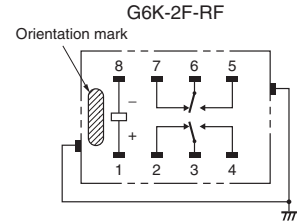

Note: 1. Each value has a tolerance of ± 0.3 mm.
2. The coplanarity of the terminals is 0.15 mm max.

G6K-2F-RF-S
G6KU-2F-RF-S

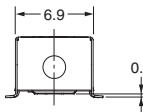
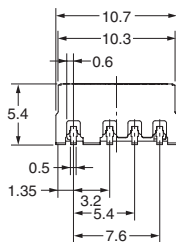
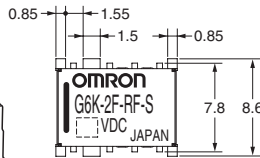
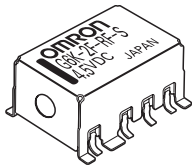

Mounting Dimensions (Top View)
Tolerance: ± 0.1 mm

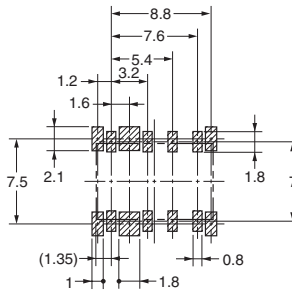

Terminal Arrangement/Internal Connections (Top View)

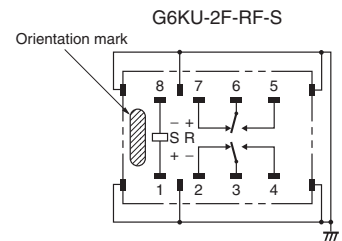
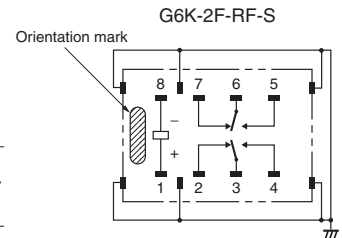

Note: 1. Each value has a tolerance of ± 0.3 mm.
2. The coplanarity of the terminals is 0.15 mm max.

G6K-2F-RF-T
G6KU-2F-RF-T

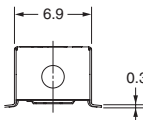
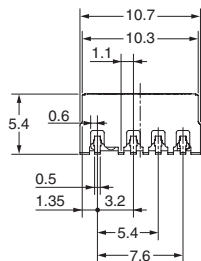
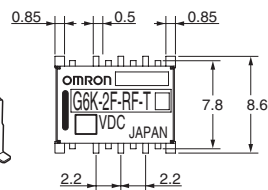
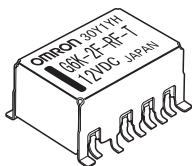

Mounting Dimensions (Top View)
Tolerance: ± 0.1 mm

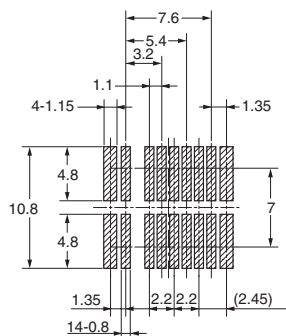

Terminal Arrangement/Internal Connections (Top View)

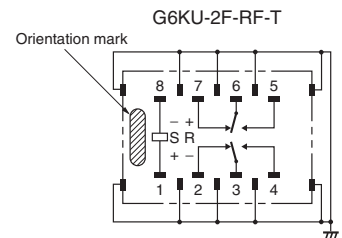
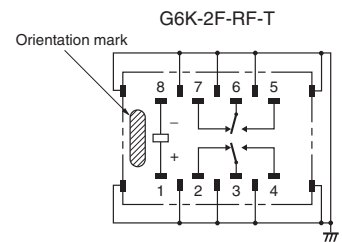

Note: 1. Each value has a tolerance of ± 0.3 mm.
2. The coplanarity of the terminals is 0.15 mm max.

Tape Packing Specifications (Surface-mounting Terminal Relays)

- Add “-TR03” or “-TR09” to the end of the model number to order Relays in tape packing. If “-TR” is not added, the Relays will be provided in tray packing.
 Relays per reel: 300 for “-TR03”
 900 for “-TR09”

1. Direction of Relay Insertion

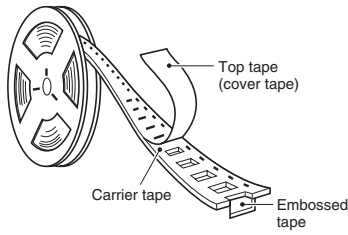

Pulling Direction

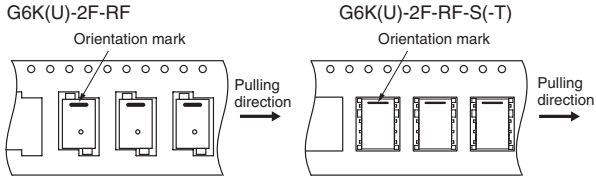

2. Reel Dimensions

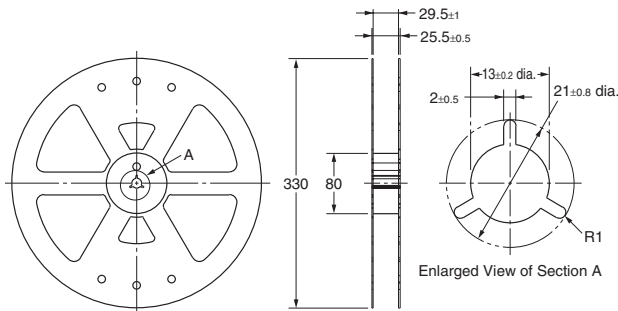

3. Carrier Tape Dimensions

G6K(U)-2F-RF

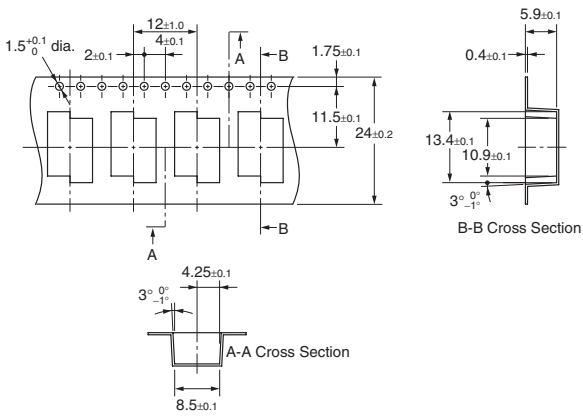

G6K(U)-2F-RF-S(-T)

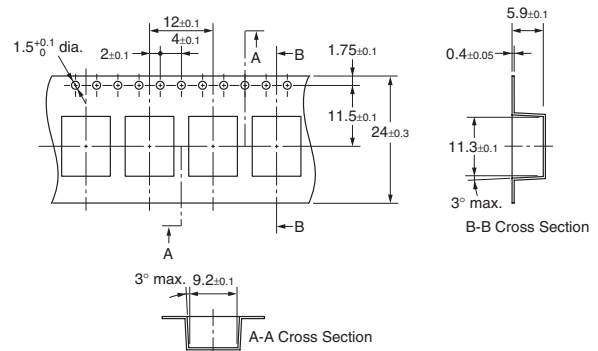

Recommended Soldering Method

Recommended Conditions for IRS Method (Surface-mounting Terminals)

(1) IRS Method (Mounting Solder: Lead)

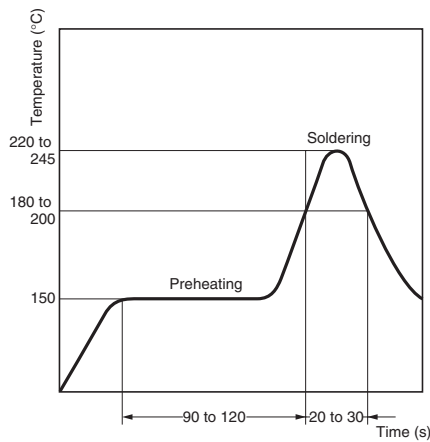

Note: The temperature profile indicates the temperature on the circuit board surface.

(2) IRS Method (Mounting Solder: Lead-free)

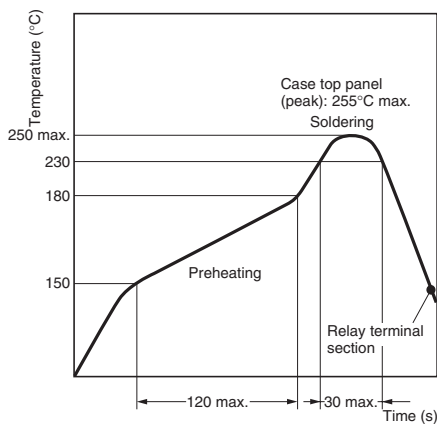

Note: The temperature profile indicates the temperature on the PCB.

The thickness of cream solder to be applied should be between 200 and 250 μm and the land pattern should be based on OMRON's recommended PCB pattern.

To maintain the correct soldering joint shown in the following diagram, we recommend applying solder with the soldering conditions shown on the left.

Correct Soldering

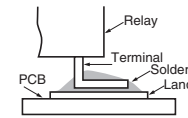

Incorrect Soldering

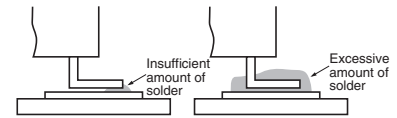

Check the soldering in the actual mounting conditions before use.

Safety Precautions

For general precautions, refer to the *PCB Relays Catalog (X033)*. Familiarize yourself with the precautions and glossary before using the G6K(U)-2F-RF.

■ Precautions for Correct Use

Relay Handling

Use the Relay as soon as possible after opening the moisture-proof package. If the Relay is left for a long time after opening the moisture-proof package, the appearance may suffer and seal failure may occur after the solder mounting process. To store the Relay after opening the moisture-proof package, place it into the original package and seal the package with adhesive tape.

When washing the product after soldering the Relay to a PCB, use a water-based solvent or alcohol-based solvent and keep the solvent temperature to less than 40°C. Do not put the Relay in a cold cleaning bath immediately after soldering.

Environmental Conditions for Usage, Storage, and Transport

Avoid direct sunlight when using, storing, or transporting the Relay and maintain normal temperature, humidity, and pressure conditions.

Long-term, Continuous ON Contacts

Using the Relay in a circuit where the Relay will be ON continuously for long periods (rather than switching) can lead to unstable contacts because the heat generated by the coil itself will affect the insulation and can cause a film to develop on the contact surfaces. We recommend using a latching relay (magnetic-holding relay) in this kind of circuit. If a single-side stable model must be used in this kind of circuit, we recommend adding fail-safe circuits in case the contact fails or the coil burns out.

Claw Securing Force During Automatic Mounting

During automatic insertion of Relays, be sure to set the securing force of each claw to the following so that the Relay's characteristics will be maintained.

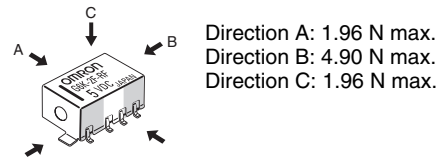

Direction A: 1.96 N max.
Direction B: 4.90 N max.
Direction C: 1.96 N max.

Secure the claws to the shaded area.
Do not attach them to the center of the Relay or just one part of the Relay.

Coating

Do not use silicone coating to coat the Relay when it is mounted to the PCB. Do not wash the PCB after the Relay is mounted using detergent containing silicone. Otherwise, the detergent may remain on the surface of the Relay.

Repeatability

Contact your OMRON representative if the Relay will be used in an application that requires high repeatability in high-frequency characteristics for the microload region. (Such applications include testing and measurement equipment and ATE applications.)

ALL DIMENSIONS SHOWN ARE IN MILLIMETERS.

To convert millimeters into inches, multiply by 0.03937. To convert grams into ounces, multiply by 0.03527.