

Photomicrosensor (Reflective)

EE-SY193

This announcement is based on product catalogue information previously shown before its discontinuation.

Product information of the existing product may be different from this version.

Ultra-compact SMD Type with a detectable sensing distance of 1 mm

- PCB surface mounting type.



Be sure to read *Safety Precautions* on page 3.

RoHS Compliant



Model Number Structure

EE-S Y 1 93

(1) (2) (3) (4)

(1) Photomicrosensor (2) Reflective (3) Phototransistor output (4) Serial number

Ordering Information

Photomicrosensor

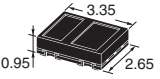
Appearance	Sensing method	Connecting method	Sensing distance	Output type	Model	Minimum packing unit (Unit: pcs)/
	Reflective	SMT	1 mm	Phototransistor	EE-SY193 *	3,000 *

* Types with 100 pcs/box re available. The model name for ordering is EE-SY193-1.

Note: Order in multiples of minimum packing unit.

Ratings, Characteristics and Exterior Specifications

Absolute Maximum Ratings (Ta = 25°C)

Item	Symbol	Rated value	Unit
Emitter			
Forward current	I _F	25 *1	mA
Pulse forward current	I _{FP}	100 *2	A
Reverse voltage	V _R	6	V
Detector			
Collector-Emitter voltage	V _{CEO}	18	V
Emitter-Collector voltage	V _{ECO}	4	V
Collector current	I _C	20	mA
Collector dissipation	P _C	75 *1	mW
Ambient temperature			
Operating	T _{opr}	-30 to 80	°C
Storage	T _{stg}	-40 to 85	°C
Reflow soldering	T _{sol}	220 *3	°C
Manual soldering	T _{sol}	300 *3	°C

*1. Refer to the temperature rating chart if the ambient temperature exceeds 25°C.

*2. Duty: 1/100; Pulse width: 0.1 ms

*3. Complete soldering within 10 seconds for reflow soldering and within 3 seconds for manual soldering.

Exterior Specifications

Connecting method	Weight (g)	Material
		Mold
SMT	0.014	LCP

Electrical and Optical Characteristics (Ta = 25°C)

Item	Symbol	Value			Unit	Condition	
		MIN.	TYP.	MAX.			
Emitter	Forward voltage	V _F	---	1.1	1.3	V	I _F = 4 mA
	Reverse current	I _R	---	---	10	μA	V _R = 6 V
	Peak emission wavelength	λ _P	---	940	---	nm	I _F = 20 mA
Detector	Light current	I _L	100	150	360	μA	Aluminum deposited surface, I _F = 4 mA, V _{CE} = 2 V, d = 1 mm *
	Dark current	I _D	---	---	100	nA	V _{CE} = 10 V, 0 lx
	Leakage current	I _{LEAK}	---	---	1	μA	I _F = 4 mA, V _{CE} = 2 V
	Collector-Emitter saturated voltage	V _{CE (sat)}	---	---	---	---	---
	Peak spectral sensitivity wavelength	λ _P	---	900	---	nm	---
Rising time	t _r	---	25	---	μs	V _{CC} = 2 V, R _L = 1 kΩ,	
Falling time	t _f	---	30	---	μs	V _{CC} = 2 V, R _L = 1 kΩ,	

* The letter "d" indicates the distance between the top surface of the sensor and the sensing object.

This announcement is based on product catalogue information previously shown before its discontinuation.

Product information of the existing product may be different from this version.

Engineering Data

Fig 1. Forward Current vs. Collector Dissipation Temperature Rating

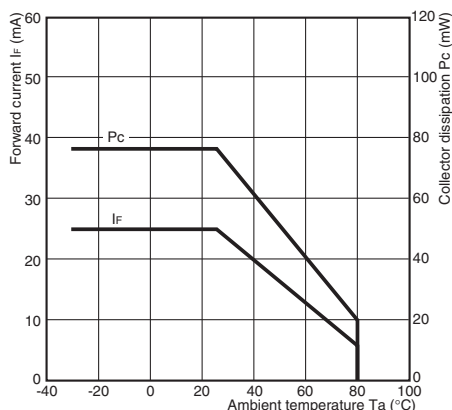

Fig 2. Forward Current vs. Forward Voltage Characteristics (Typical)

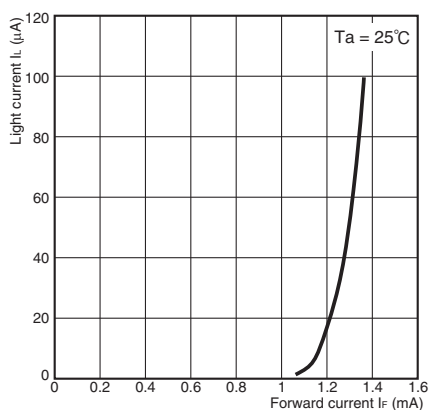

Fig 3. Light Current vs. Forward Current Characteristics (Typical)

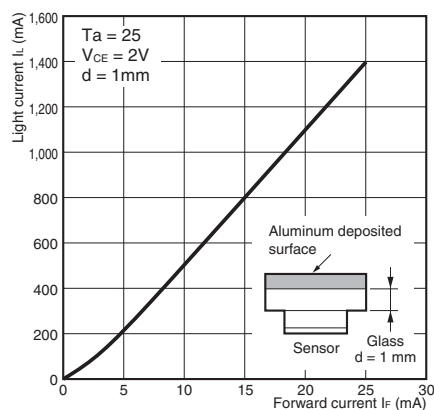

Fig 4. Light Current vs. Collector-Emitter Voltage Characteristics (Typical)

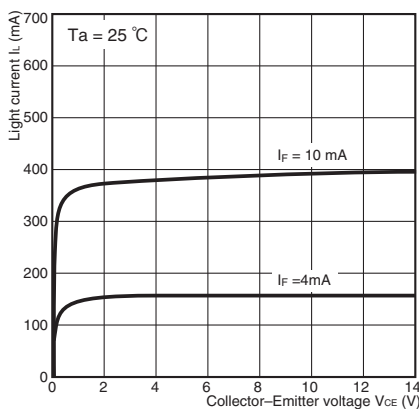

Fig 5. Relative Light Current vs. Ambient Temperature Characteristics (Typical)

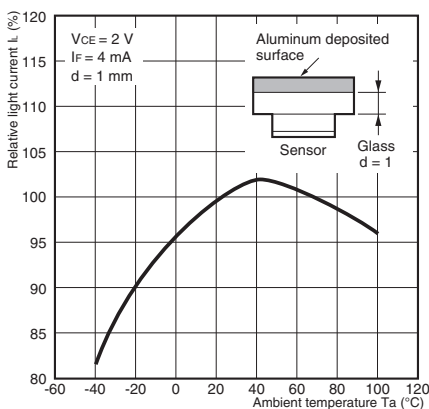

Fig 6. Dark Current vs. Ambient Temperature Characteristics (Typical)

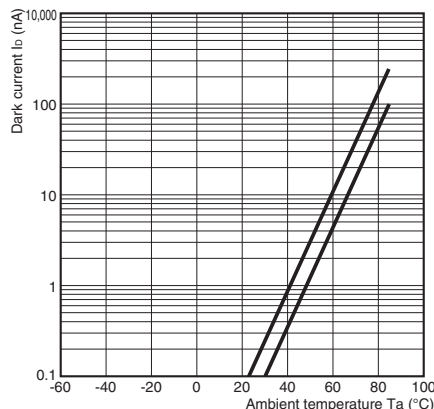

Fig 7. Response Time vs. Load Resistance Characteristics (Typical)

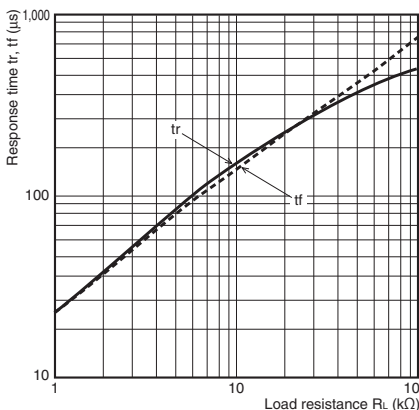

Fig 8. Sensing Distance Characteristics (Typical)

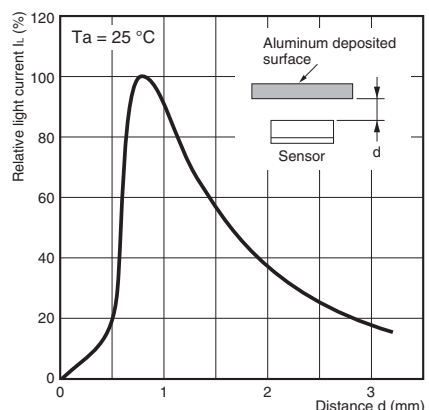

Fig 9. Sensing Position Characteristics (Typical)

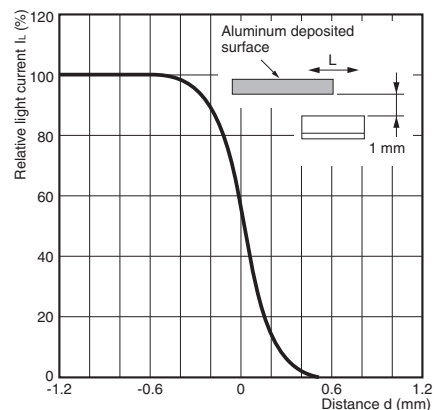
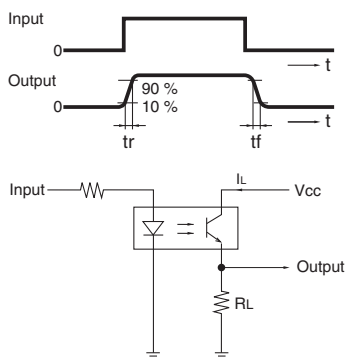

Fig 10. Response Time Measurement Circuit



This announcement is based on product catalogue information previously shown before its discontinuation.

Product information of the existing product may be different from this version.

Safety Precautions

To ensure safe operation, be sure to read and follow the Instruction Manual provided with the Sensor.

CAUTION

This product is not designed or rated for ensuring safety of persons either directly or indirectly. Do not use it for such purposes.



Precautions for Safe Use

Do not use the product with a voltage or current that exceeds the rated range.

Applying a voltage or current that is higher than the rated range may result in explosion or fire.

Do not miswire such as the polarity of the power supply voltage.

Otherwise the product may be damaged or it may burn.

This product does not resist water. Do not use the product in places where water or oil may be sprayed onto the product.

Precautions for Correct Use

Do not use the product in atmospheres or environments that exceed product ratings. This product is for surface mounting. Refer to Soldering Information, Storage and Baking for details.

Dispose of this product as industrial waste.

Dimensions and Internal Circuit

(Unit: mm)

Photomicrosensor

EE-SX193

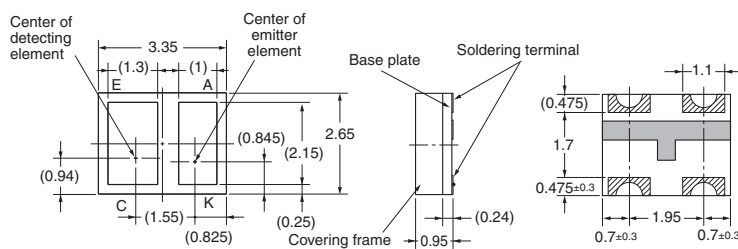
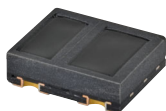

Internal Circuit

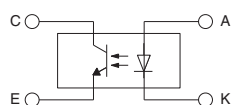

Terminal No.	Name
A	Anode
K	Cathode
C	Collector
E	Emitter

Recommended soldering patterns

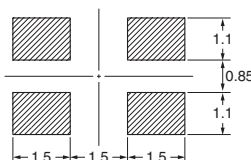

Unless otherwise specified, the tolerances are ± 0.2 mm.

This announcement is based on product catalogue information previously shown before its discontinuation.

Product information of the existing product may be different from this version.

Tape and Reel

Reel (Unit: mm) *

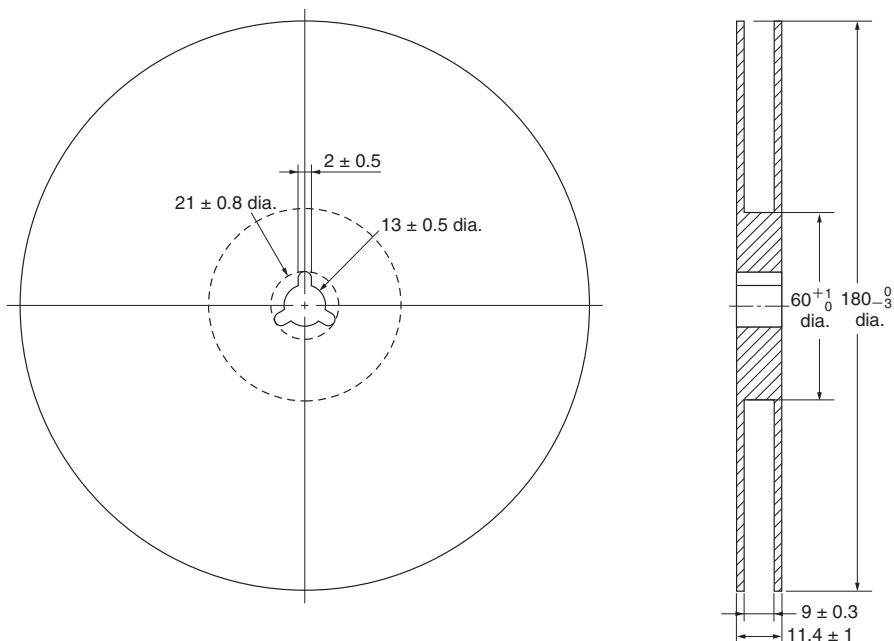

Tape (Unit: mm)

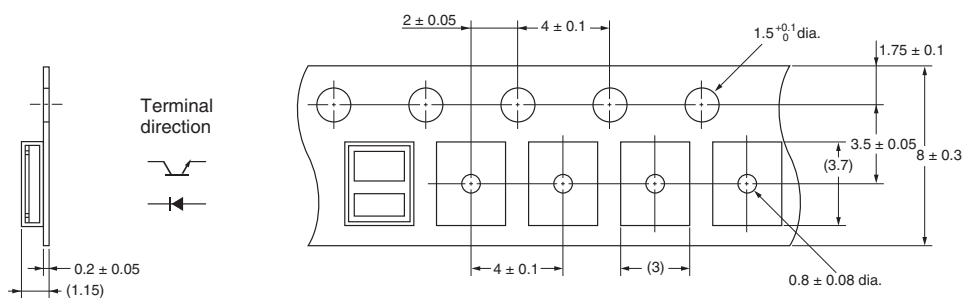

Tape configuration

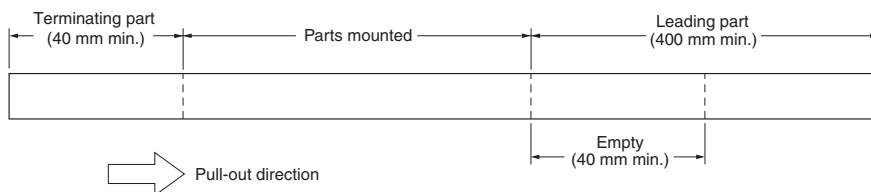

Tape quantity

3,000 pcs./reel
100 pcs./pack *

* EE-SY193-1 (100 pcs./pack) has no reel, only tape is attached.

Soldering Information

Reflow soldering: Temperature profile

1. The following soldering paste is recommended:
Melting temperature: 178 to 192°C
2. The recommended thickness of the metal mask for screen printing is between 0.2 and 0.25 mm.
3. Set the reflow oven so that the temperature profile shown in the following chart is obtained for the upper surface of the product being soldered.

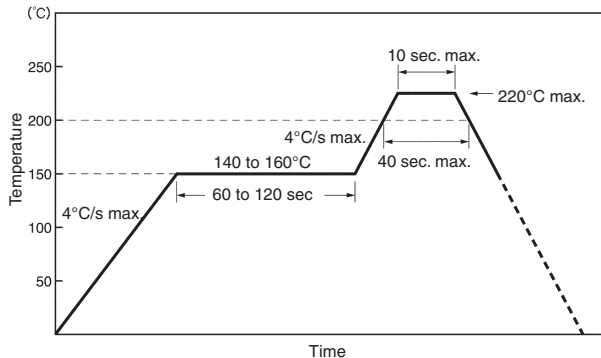

Manual soldering

1. Use "Sn 60" (60% tin and 40% lead) or solder with silver content.
2. Use a soldering iron of less than 25 W, and keep the temperature of the iron tip at 300°C or below.
3. Solder each point for a maximum of three seconds.
4. After soldering, allow the product to return to room temperature before handling it.

Storage

Storage conditions

To protect the product from the effects of humidity until the package is opened, dry-box storage is recommended. If this is not possible, store the product under the following conditions:

Temperature: 10 to 30°C
Humidity: 60% RH max.

Treatment after open

1. The product is packed in a humidity-proof envelope. Reflow soldering must be done within 48 hours after opening the envelope, during which time the product must be stored under 30°C at 80% maximum humidity.
2. If it is necessary to store the product after opening the envelope, use dry-box storage or reseal the envelope.

Baking

If a product has remained packed in a humidity-proof envelope for six months or more, or if more than 48 hours have lapsed since the envelope was opened, bake the product under the following conditions before use:

Reel: 60°C for 24 hours or more
Bulk: 80°C for 24 hours or more

This announcement is based on product catalogue information previously shown before its discontinuation.

Product information of the existing product may be different from this version.

Please check each region's Terms & Conditions by region website.

OMRON Corporation

Electronic and Mechanical Components Company

Regional Contact

Americas

<https://www.components.omron.com/>

Asia-Pacific

<https://ecb.omron.com.sg/>

Korea

<https://www.omron-ecb.co.kr/>

Europe

<http://components.omron.eu/>

China

<https://www.ecb.omron.com.cn/>

Japan

<https://www.omron.co.jp/ecb/>