

This announcement is based on product catalogue information previously shown before its discontinuation.  
Product information of the existing product may be different from this version.

# Photomicrosensor (Actuator Mounted) EE-SA107-P2

**⚠ Be sure to read *Precautions* on page 24.**

## ■ Dimensions

**Note:** All units are in millimeters unless otherwise indicated.

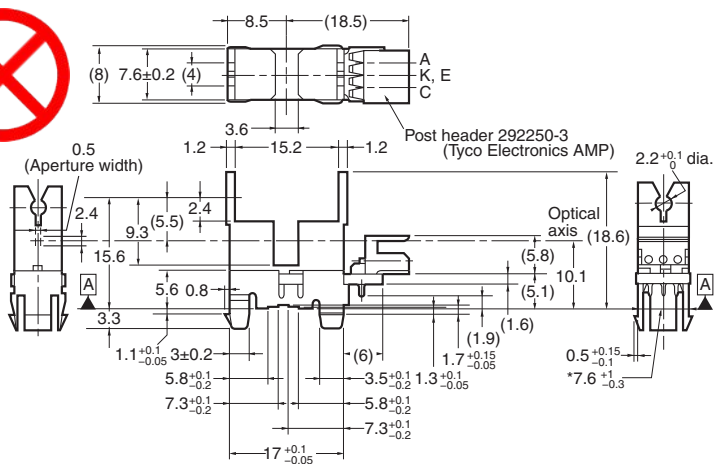

Internal Circuit

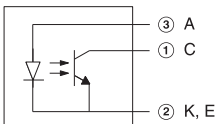

**Note:** The asterisked dimension is specified by datum A only.

Unless otherwise specified, the tolerances are as shown below.

Dimensions	Tolerance
3 mm max.	±0.3
3 < mm £ 6	±0.375
6 < mm £ 10	±0.45
10 < mm £ 18	±0.55
18 < mm £ 30	±0.65

Terminal No.	Name
A	Anode
K	Cathode
C	Collector
E	Emitter

Recommended Mating Connectors:

- Tyco Electronics AMP 179228-3 (crimp connector)
- 173977-3 (press-fit connector)
- 175778-3 (crimp connector)

## ■ Features

- An actuator can be attached.
- Snap-in mounting model.
- Mounts to 1.0-, 1.2- and 1.6-mm-thick PCBs.
- Connects to Tyco Electronics AMP's CT-series connectors.

## ■ Absolute Maximum Ratings (Ta = 25°C)

Item	Symbol	Rated value
Emitter	Forward current	$I_F$ 50 mA (see note)
	Pulse forward current	$I_{FP}$ ---
	Reverse voltage	$V_R$ 4 V
Detector	Collector-Emitter voltage	$V_{CEO}$ 30 V
	Emitter-Collector voltage	$V_{ECO}$ 5 V
	Collector current	$I_C$ 20 mA
	Collector dissipation	$P_C$ 100 mW (see note)
Ambient temperature	Operating	$T_{opr}$ -25°C to 85°C
	Storage	$T_{stg}$ -40°C to 85°C
Soldering temperature	$T_{sol}$	---

**Note:** Refer to the temperature rating chart if the ambient temperature exceeds 25°C.

## ■ Electrical and Optical Characteristics (Ta = 25°C)

Item	Symbol	Value	Condition
Emitter	Forward voltage	$V_F$ 1.2 V typ., 1.5 V max.	$I_F = 30$ mA
	Reverse current	$I_R$ 0.01 $\mu$ A typ., 10 $\mu$ A max.	$V_R = 4$ V
	Peak emission wavelength	$\lambda_P$ 940 nm typ.	$I_F = 30$ mA
Detector	Light current	$I_L$ 0.5 mA min., 14 mA max.	$I_F = 20$ mA, $V_{CE} = 5$ V
	Dark current	$I_D$ 200 nA max.	$V_{CE} = 10$ V, 0 lx
	Leakage current	$I_{LEAK}$ ---	---
	Collector-Emitter saturated voltage	$V_{CE(sat)}$ 0.1 V typ., 0.4 V max.	$I_F = 20$ mA, $I_L = 0.3$ mA
	Peak spectral sensitivity wavelength	$\lambda_P$ 850 nm typ.	$V_{CE} = 5$ V
	Rising time	$t_r$ 8 $\mu$ s typ.	$V_{CC} = 5$ V, $R_L = 100 \Omega$ , $I_L = 1$ mA
Falling time	$t_f$ 8 $\mu$ s typ.	$V_{CC} = 5$ V, $R_L = 100 \Omega$ , $I_L = 1$ mA	

This announcement is based on product catalogue information previously shown before its discontinuation.  
Product information of the existing product may be different from this version.

## Engineering Data

**Forward Current vs. Collector Dissipation Temperature Rating**

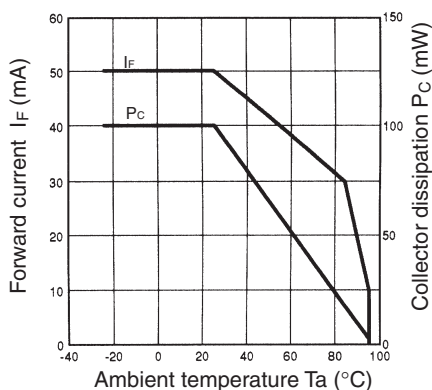

**Forward Current vs. Forward Voltage Characteristics (Typical)**

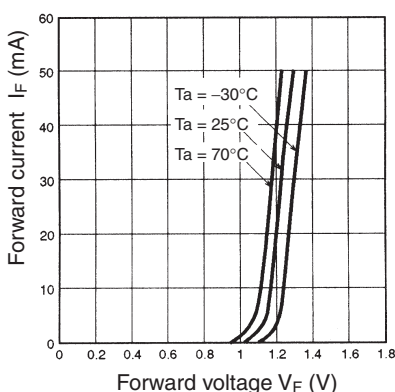

**Light Current vs. Forward Current Characteristics (Typical)**

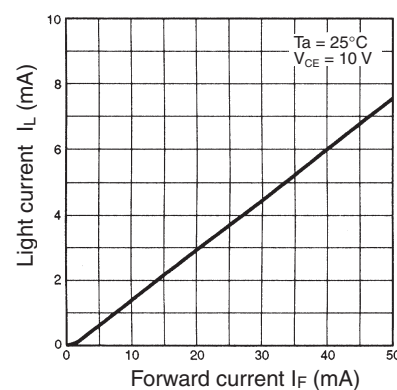

**Light Current vs. Collector-Emitter Voltage Characteristics (Typical)**

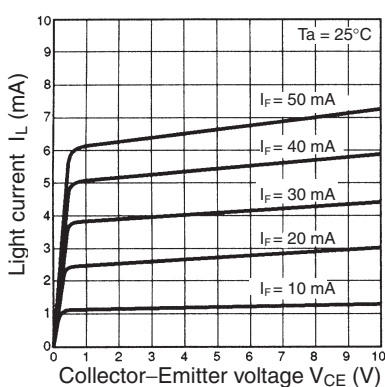

**Relative Light Current vs. Ambient Temperature Characteristics (Typical)**

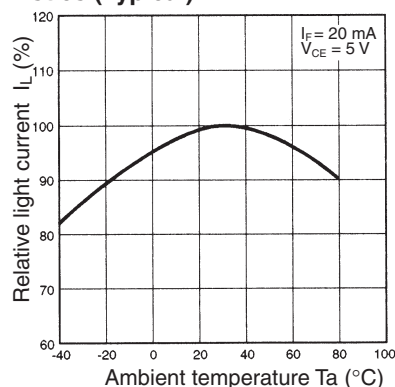

**Dark Current vs. Ambient Temperature Characteristics (Typical)**

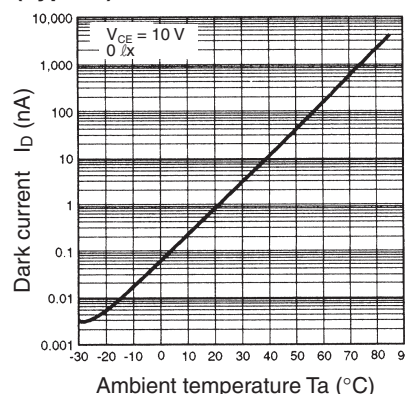

**Response Time vs. Load Resistance Characteristics (Typical)**

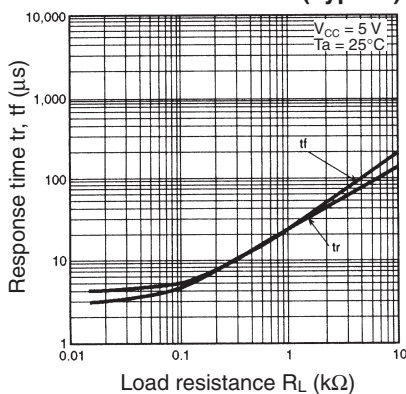

**Sensing Position Characteristics (Typical)**

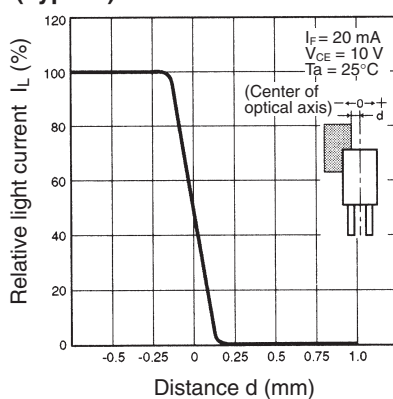

**Sensing Position Characteristics (Typical)**

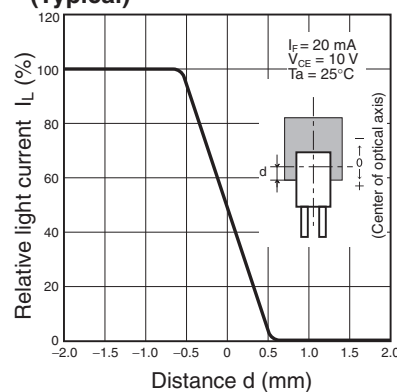

**Response Time Measurement Circuit**

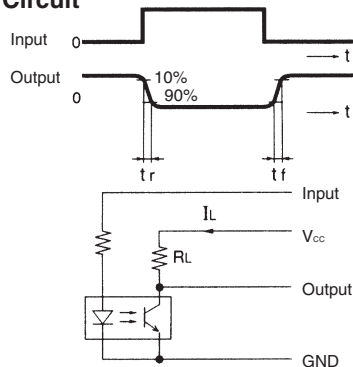

**Actuator Dimensions**

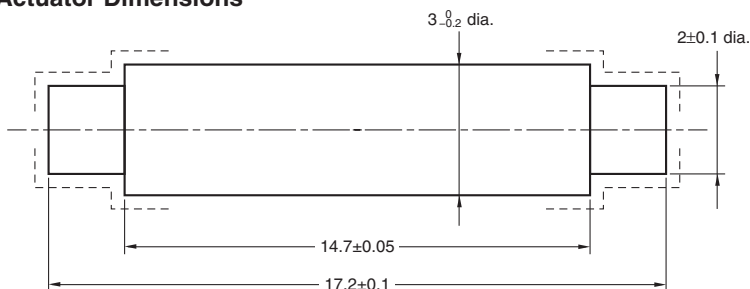

- Note:** 1. Make sure that the portions marked with dotted lines have no burrs.  
2. The material of the actuator must be selected by considering the infrared permeability of the actuator.