

■ Precautions

Correct Use

● Grounding

To ground, create copper foil around the Connector Attachment hole on the board, assemble the Connector and Grounding Fixtures, and dip in solder as shown below.

● Tap Hole Grounding Fixtures

Insert the Connector into the PCB, tighten the screws, and then dip-solder the Connector terminals to the board.

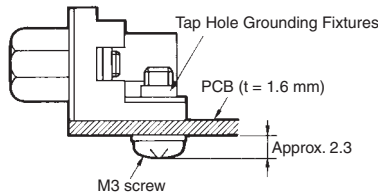

● Lock Pin Grounding Fixtures

Insert the connector into the PCB and then simultaneously dip-solder the Connector terminals and lock pin to the board.

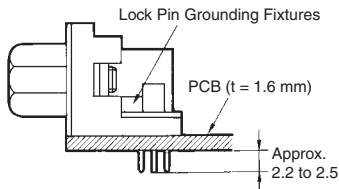

● Attaching the Dust Cover

To attach the cord to the Connector, use Anchor 1 and secure it as shown below.

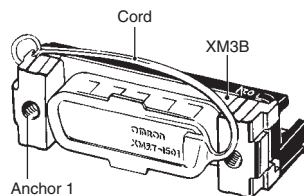

- If the cord is not required, cut it off or use a model without the cord.
- To attach the cord to a panel, drill an M3 hole in the panel and secure the cord to it with an M3 screw. Use commercially available M3 screw.

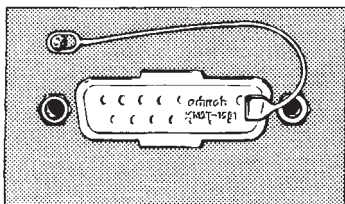

● Tightening Clamp Screws

Use the following torques when tightening cable clamp to hoods.

Terminal Screw Tightening Torque (N-m)

9 contacts	15 contacts	25 contacts	37 contacts
0.25	0.44	0.49	

● Shielded Cable Preparation

Refer to the following diagram when soldering shielded cable to the Connector when using a Hood.

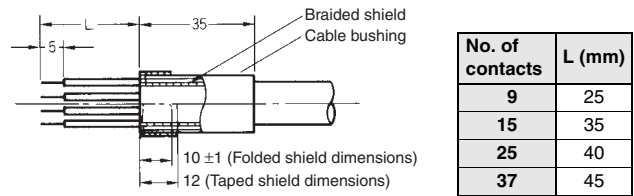

1. Fold the unravelled braided shield back over the cable bushing.

2. Wrap tape around the folded shield.

● Tightening torque for anchors and grounding fixtures

Tighten anchors to connector bodies and screws intended to immobilize grounding fixtures to 0.49 N-m. Also, use a proper size tool to do this work.

● Shield Effects

- When connecting the braided cable shield to a Connector Hood, use the cable clamp to clamp all the braids at once through the shielded tape.
- Mate the lock screw washer and spring washer outside the Connector when assembling the Hood.

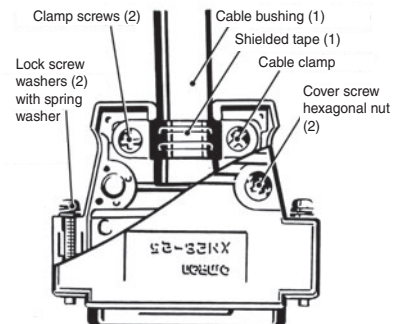

- Keep the shell flange of the Connector as far away from the metal panel as possible to maximize the shield effect with a Connector mounted to the panel.
- The ground wire for the Connector will fall into the shell (external metal covering) with Solder-cup Terminals, so connect the ground wire to the panel or to ground on the board.

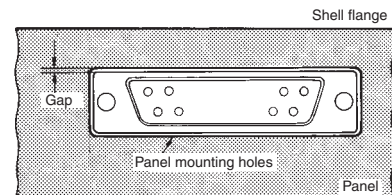

● XM3A/XM3D Connector Insertion and Removal

- Grasp the Connector or the Hood Cover when inserting and removing the Connector. Never try to remove the Connector by pulling the cable.

● Soldering

Automated Soldering Conditions (Jet Flow) (XM3B, XM3C, and XM3F)

1. Soldering temperature: 250 ±5°C
2. Continuous soldering time: Within 5 s

- Application examples provided in this document are for reference only. In actual applications, confirm equipment functions and safety before using the product.
- Consult your OMRON representative before using the product under conditions which are not described in the manual or applying the product to nuclear control systems, railroad systems, aviation systems, vehicles, combustion systems, medical equipment, amusement machines, safety equipment, and other systems or equipment that may have a serious influence on lives and property if used improperly. Make sure that the ratings and performance characteristics of the product provide a margin of safety for the system or equipment, and be sure to provide the system or equipment with double safety mechanisms.

Note: Do not use this document to operate the Unit.