



OMRON Corporation
Electronic and Mechanical
Components Company

Human Vision Components (HVC-P2)

B5T-007001

Command Specifications

■ Trademarks

“OKAO” and “OKAO Vision” are registered trademarks of OMRON Corporation in Japan.

■ Revision History

Rev	Contents	Prepared by	Reviewed by	Approved by
A	First release	AOB 2016/07/12 Tanaka	AOB 2016/07/12 Murakami	AOB 2016/07/12 Yamada
B	Minor changes	S&MH 2018/07/24 Tanaka	S&MH 2018/07/24 Urabe	S&MH 2018/07/24 M.Tanaka

■ Additional Notes

You may not reproduce, duplicate or copy the contents of this software specification document without proper written authorization from OMRON Corporation unless if for its intended proper use. The contents of this software specification document may change without notice.

TABLE OF CONTENTS

1 OUTLINE	5
1.1 B5T-007001 DEVICE.....	5
1.2 IMAGE DATA AND DETECTION RESULT	6
2 FUNCTION DESCRIPTION.....	7
2.1 HUMAN BODY DETECTION	8
2.2 HAND DETECTION	9
2.3 FACE DETECTION	10
2.4 FACE DIRECTION ESTIMATION	11
2.5 AGE ESTIMATION	12
2.6 GENDER ESTIMATION.....	13
2.7 GAZE ESTIMATION	14
2.8 BLINK ESTIMATION	15
2.9 EXPRESSION ESTIMATION	16
2.10 FACE RECOGNITION	17
2.11 IMAGE OUTPUT	19
3 PROCESS FLOW	20
3.1 COMMAND FLOW.....	20
3.2 HOST PROCESS FLOW	21
3.3 DETECTION PROCESS FLOW	23
3.4 REGISTRATION PROCESS FLOW	24
3.5 END PROCESS FLOW	25
4 COMMAND SPECIFICATIONS.....	26
4.1 FORMATS.....	26
4.1.1 Command Format	26
4.1.2 Response Format	26
4.2 COMMAND LIST	27
4.3 COMMAND DESCRIPTION.....	28
4.3.1 Get Model and Version	28
4.3.2 Set Camera Angle	29
4.3.3 Get Camera Angle	31
4.3.4 Execute detection.....	32
4.3.5 Set Threshold Values	39
4.3.6 Get Threshold Values.....	40
4.3.7 Set Detection Size.....	41
4.3.8 Get Detection Size	42
4.3.9 Set Face Angle	43
4.3.10 Get Face Angle	44
4.3.11 Set UART Forwarding Rate.....	45
4.3.12 Register Data (Face Recognition).....	46
4.3.13 Delete Specified Data (Face Recognition)	47
4.3.14 Delete Specified User (Face Recognition).....	48
4.3.15 Delete All Data (Face Recognition).....	49
4.3.16 Get Registration Info (Face Recognition).....	50
4.3.17 Save Album (Face Recognition).....	51
4.3.18 Load Album (Face Recognition)	52
4.3.19 Save Album in Flash ROM (Face Recognition).....	53
4.3.20 Reformat Flash ROM (Face Recognition).....	53
4.4 RESPONSE CODE LIST	54
4.5 ADDITIONAL NOTES.....	55
5 COMMAND TIMEOUT	56
5.1 DEFINITION OF COMMAND TIMEOUT.....	56
5.2 ADDITIONAL NOTES ON COMMAND TIMEOUT.....	56
5.3 COMMAND TIMEOUT CALCULATION	56
5.3.1 Command timeout for commands	56
5.3.2 Command timeout for function commands	57
5.3.3 Command timeout for Save/Load Album.....	58

5.3.4 Command timeout for Save Album on flash ROM	58
6 TROUBLESHOOTING.....	59
6.1 PROCEDURE ERRORS	59
6.2 RESPONSE ERRORS	60

1 Outline

This document is the manual describing the specifications of the commands used to operate the OMRON Corporation B5T-007001 Device.

1.1 B5T-007001 Device

The B5T-007001 device (hereafter referred to as the “Device”) incorporates 10 algorithms of the **OKAO™ Vision** Image Sensing Technology to recognize the conditions of people. Information on people's conditions can be obtained by just mounting the Device on equipment.

The Device will detect human bodies (upper-body), hands (palms) and faces and output that detection result. The face direction, age, gender, gaze direction, blink degree, expression and face recognition result info can be obtained after detecting a face.

Note that pre-registration of recognition data for the faces to be recognized is required in order to use the recognition function.

Refer to **2 Function Description** for details on the available functions.

1.2 Image Data and Detection Result

The image data size taken by the Device is 1600×1200 pixels.

The result info of the detected human bodies, hands or faces will include their position (center x & y coordinates), size and degree of confidence.

The position is output in a coordinate system with the top-left corner of the image as the point of origin (0,0).

When the camera angle is set to 90° or 270°, the image data size will become 1200×1600.

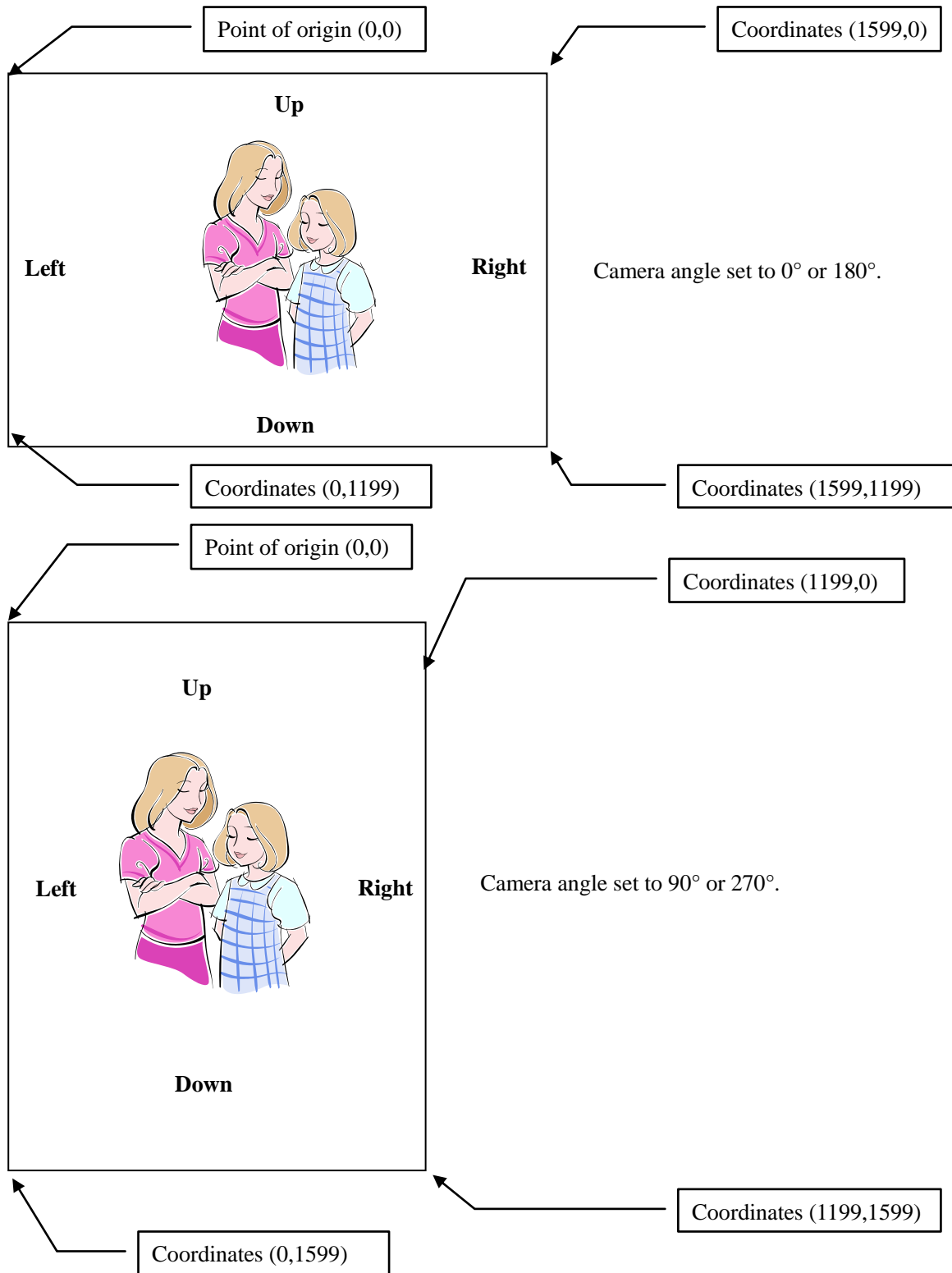

2 Function Description

The following functions are available in the Device.

Number	Function name	Function description
1	Human Body Detection	Detects human body (upper-half)
2	Hand Detection	Detects hands (open palms)
3	Face Detection	Detects faces
4	Face Direction Estimation	Estimates the direction of detected faces
5	Age Estimation	Estimates the age of detected faces
6	Gender Estimation	Estimates the gender of detected faces
7	Gaze Estimation	Estimates the gaze direction of detected faces
8	Blink Estimation	Estimates the blink degree of detected faces
9	Expression Estimation	Estimates the expression of detected faces
10	Face Recognition	Recognizes detected faces
11	Image Output	Output the image displaying the detection results

2.1 Human Body Detection

Human Body Detection will detect human bodies (upper half of the body) in the image data. The result info will include the number of human bodies detected and their respective position (center point coordinates), size and degree of confidence. The width and height of the size will have the same value.

The coordinates of the human body are the coordinates of the center of the rectangle circumscribing the detected human body with the upper side touching the top of the head. The width and height will be the human body size. Consider these as a rough approximation.

The degree of confidence (0 to 1000) indicates the confidence in the detection result. Detection results will only be output when their degree of confidence is above the set threshold value.

The setting for the sizes to be detected can be changed through a command. However, note that having a smaller detection size set will require a longer processing time.

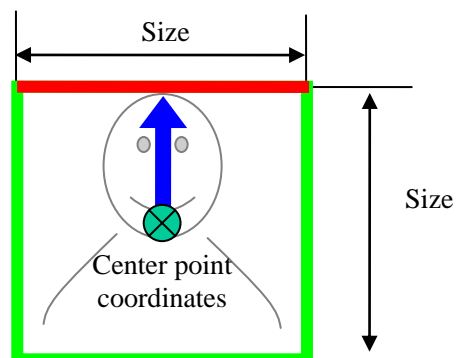

Refer to **4.3.4 Execute detection** for details on the output result info.

2.2 Hand Detection

Hand Detection will detect hands (open palms) in the image data. Note that only frontal hands (hands with the palm facing the camera) will be detected. The result info will include the number of hands detected and their respective position (center point coordinates), size and degree of confidence. The size of the hands (**R**) is displayed below. Consider these as a rough approximation.

The degree of confidence (0 to 1000) indicates the confidence in the detection result. Detection results will only be output when their degree of confidence is above the set threshold value.

The setting for the sizes to be detected can be changed through a command. However, note that having a smaller detection size set will require a longer processing time.

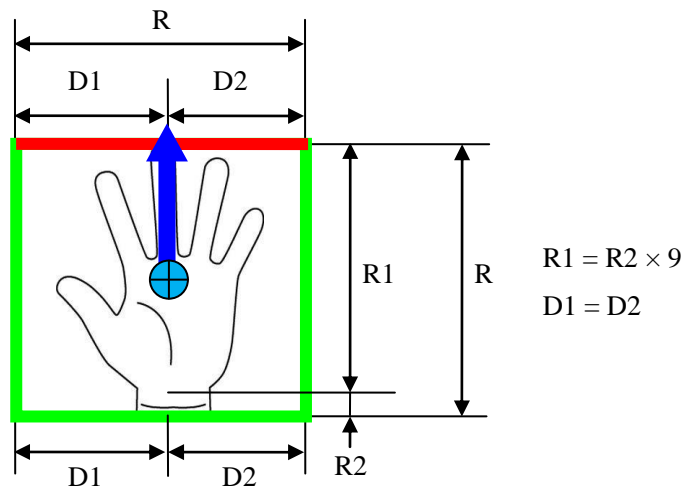

Refer to **4.3.4 Execute detection** for details on the output result info.

2.3 Face Detection

Face Detection will detect faces in the image data. The result info will include the number of faces detected and their respective position (center point coordinates), size and degree of confidence. The position and size of the faces (D1) are displayed below. Consider these as a rough approximation.

The degree of confidence (0 to 1000) indicates the confidence in the detection result. Detection results will only be output when their degree of confidence is above the set threshold value.

The setting for the sizes and angles (yaw and roll angles) to be detected can be changed through a command. However, note that having a smaller detection size and a larger face angle range set will require a longer processing time.

Use the $\pm 30^\circ$ setting for the face angle when using an estimation function, i.e. **Face Direction Estimation**, **Age Estimation**, **Gender Estimation**, **Gaze Estimation**, **Blink Estimation** or **Expression Estimation**, or **Face Recognition** following a **Face Detection** process. Refer to **4.3.9 Set Face Angle** for details.

Note that a minimum detection size higher than 64 pixels is also recommended for **Face Detection**.

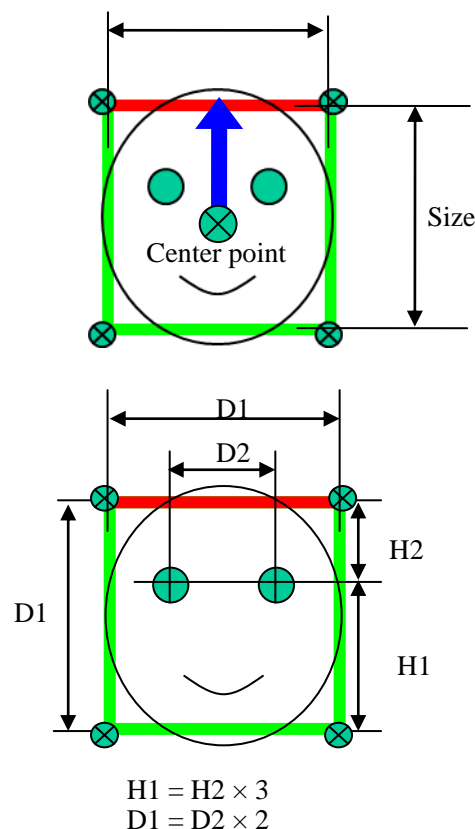

Refer to **4.3.4 Execute detection** for details on the output result info.

2.4 Face Direction Estimation

Face Direction Estimation will estimate the direction (yaw angle, pitch angle and roll angle) of the detected faces. The result info will include the yaw angle, the pitch angle, the roll angle and the degree of confidence. The degree of confidence (0 to 1000) indicates the confidence in the estimation result. A higher value will indicate a higher confidence.

For the yaw angle, a left direction will have a negative value while a right direction will have a positive value. For the pitch angle, a down direction will have a negative value while an up direction will have a positive value.

For the roll angle, a counter-clockwise inclination will have a negative value while a clockwise inclination will have a positive value.

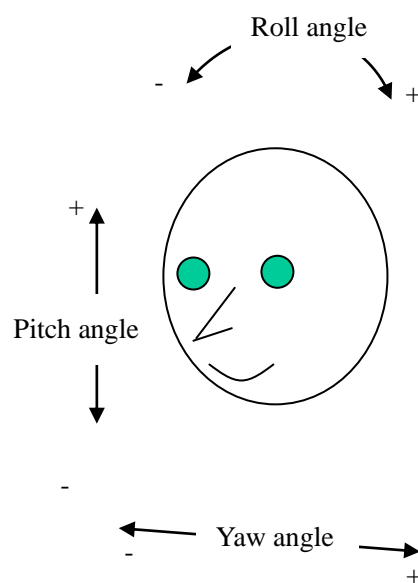

Refer to **4.3.4 Execute detection** for details on the output result info.

2.5 Age Estimation

Age Estimation will estimate the age of the detected faces. The result info will include the estimated age (0 to 75) and the degree of confidence. The value 75 will include higher ages too.

The degree of confidence (0 to 1000) indicates the confidence in the estimation result. A higher value will indicate a higher confidence.

Refer to **4.3.4 Execute detection** for details on the output result info.

2.6 Gender Estimation

Gender Estimation will estimate the gender of the detected faces. The result info will include the estimated gender (male or female) and the degree of confidence.

The degree of confidence (0 to 1000) indicates the confidence in the estimation result. A higher value will indicate a higher confidence.

Refer to **4.3.4 Execute detection** for details on the output result info.

2.7 Gaze Estimation

Gaze Estimation will estimate the gaze (yaw angle and pitch angle) of the detected faces. The result info will include the gaze yaw angle, the gaze pitch angle and the degree of confidence.

For the yaw angle, a left direction will have a negative value while a right direction will have a positive value. For the pitch angle, a down direction will have a negative value while an up direction will have a positive value.

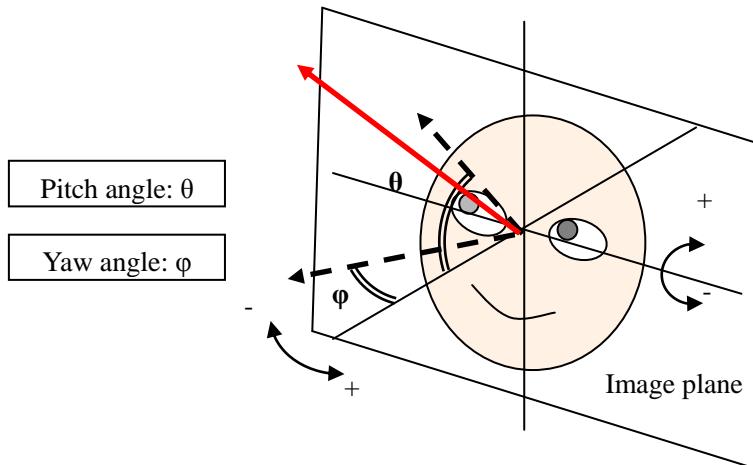

Refer to **4.3.4 Execute detection** for details on the output result info.

2.8 Blink Estimation

Blink Estimation will estimate the blink degree for both eyes of the detected faces. The result info will include the left eye blink degree, the right eye blink degree and the degree of confidence.

A higher value for the blink degree (1 to 1000) will indicate the eye is closer to being fully shut (1000).

The left eye is the actual right eye of the individual in the image, and vice versa.

Refer to **4.3.4 Execute detection** for details on the output result info.

2.9 Expression Estimation

Expression Estimation will estimate the facial expression of the detected faces. The possible expressions are the following five expressions: “neutral”, “happiness”, “surprise”, “anger” and “sadness”. The result info will include the score for each expression and the expression degree (positive/negative).

The score (0 to 100) of each expression indicates the likeliness of the face displaying the estimated expression and a higher score will indicate a higher likeliness.

The expression degree (100 to -100) indicates the general positive or negative expression in the face. A degree closer to 100 will indicate a high degree of “happiness” while a degree closer to -100 will indicate a high degree of “anger” or “sadness”. A degree of 0 indicates that the expression is neither positive nor negative.

Refer to **4.3.4 Execute detection** for details on the output result info.

2.10 Face Recognition

Face Recognition will compare the detected faces with the face recognition data registered beforehand in the Album in order to recognize them among the registered users. The result info will include the User ID registered in the Album and its score indicating the likeliness of being that recognized user.

A higher score (0 to 1000) indicates a higher likeliness of the detected face being the recognized registered user.

A detected face will be recognized as a registered user only if its score value is higher than the threshold value set. It will be identified as “not registered” if its score is lower than the threshold value.

Refer to **4.3.4 Execute detection** for details on the output result info.

The maximum number of possible registered users is 100, with up to 10 images for data per user.

The recognition data can be registered in or erased from the Album by specifying a User ID (0 to 99) and a Data ID (0 to 9).

Notes on Face Recognition Usage

1. Create the Album (register face recognition data in the Album)

Take a picture of the user to be registered with the Device and get their recognition data. The recognition data will be stored in the Album as Album data. The Album can contain data for up to 100 users, with up to 10 pictures per user. The Album data will be registered in the Album by specifying the user ID (0 to 99) and data ID (0 to 9).

The Album data will be saved on the RAM memory in the Device.

2. Execute Face Recognition

Face Recognition can be executed if recognition data is registered in the Album. Refer to **4.3.4 Execute detection** for details.

3. Save Album on Flash ROM

The Album data saved on the RAM memory in the Device can be saved on the flash ROM of the Device.

The Album data on the flash ROM will be written on the RAM of the Device when it is turned ON.

Refer to **4.3.18 Save Album on Flash ROM** for details.

4. Save and Load Album

The Album can be saved to and loaded from the Host side. Only the Album data stored on the Device RAM can be saved or loaded. It is recommended to save a backup of the Album data on the Host side too as the Album data can be lost if the power is cut from the Device when saving the Album data on the flash ROM.

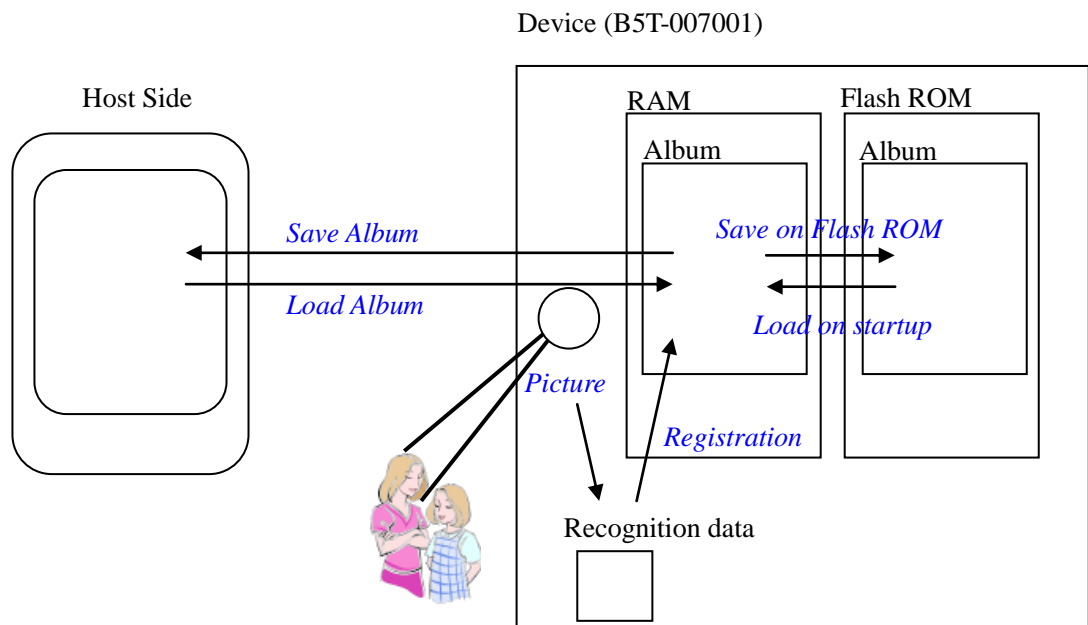

Refer to **4.3.16 Save Album** and **4.3.17 Load Album** for details.

2.11 Image Output

The Device can output the image displaying the detection results in the following formats:

- (1) 320×240 pixels
- (2) 160×120 pixels
- (3) No image output

The image output is used for the following:

- (1) Provide visual support for application development
- (2) Provide visual support when setting up the Device

This is why no format above 320×240 pixels is available.

Refer to **4.3.4 Execute detection** for details on the output image.

3 Process Flow

3.1 Command Flow

The common command flow between the Host side and the Device is as described below.

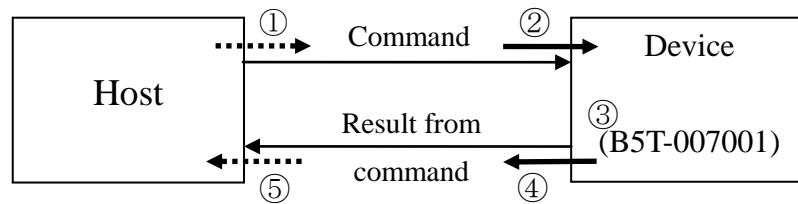

- ① The command is sent from the Host side to the Device.
- ② The Device receives the command.
- ③ The Device executes the command.
- ④ The Device sends the result of the executed command back to the Host side.
- ⑤ The Host side received the result of the executed command.

Do not send additional commands from the Host side until the result of the previously executed command are received back.

Caution

The results from the executed command may sometimes not be properly received after a set period of time if the connector transmitting the command is not properly connected. In such a case, assume a command timeout. Refer to **5 Command Timeout** for details on command timeouts.

3.2 Host Process Flow

The common process flow from the Host side controlling the Device is as described below.

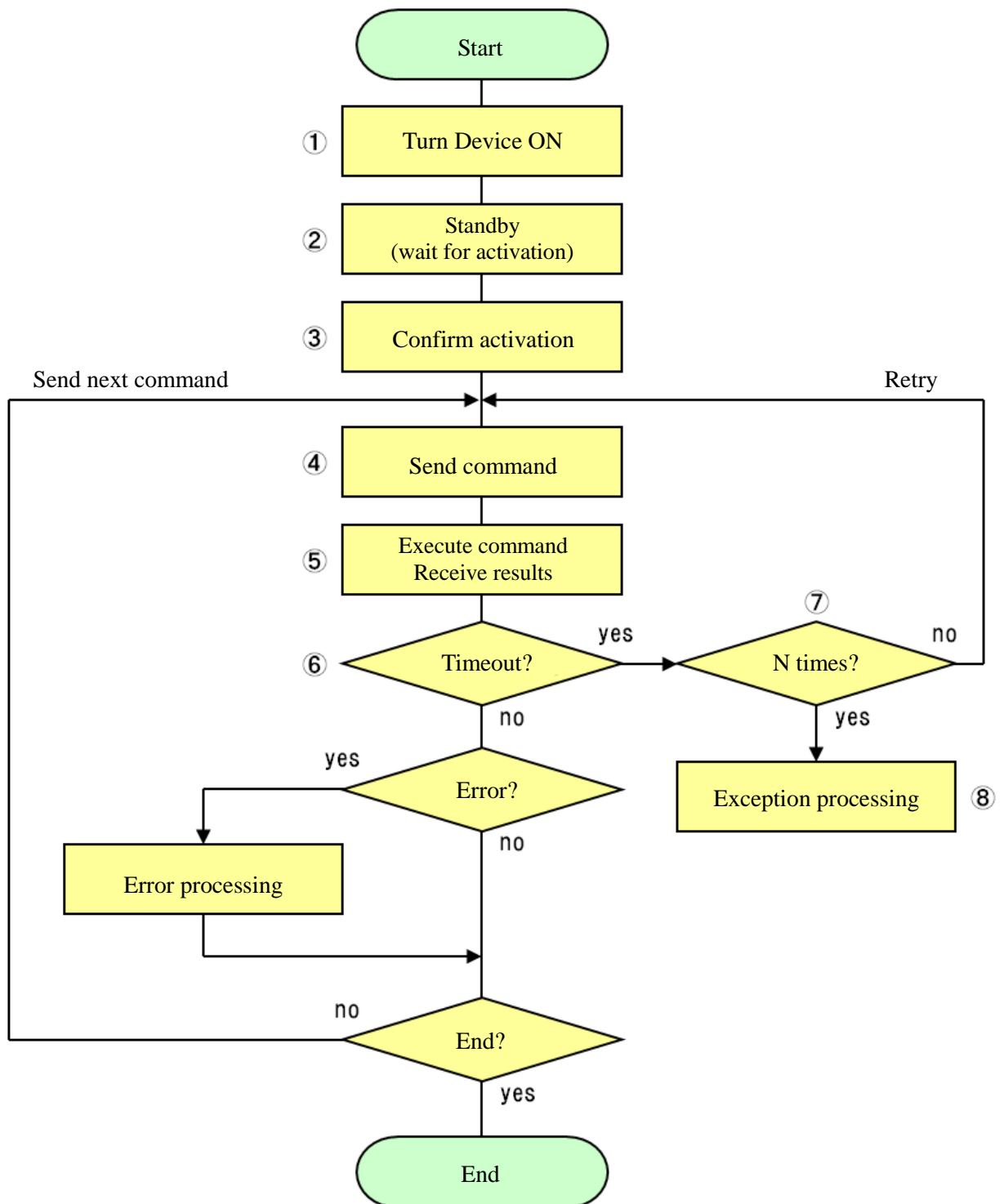

-
- ① Turn the Device ON.
- ② A standby period is required before the Device can receive commands from the Host side. The standby period is 1 second when not using **Face Recognition** and 2 seconds when using it.
- ③ Confirm that the Device is connected.
 For example, a “Get model and version” command can be sent to confirm a proper response.
 This can also be the initial command used by the application on the Host side.
 The possible explanations when a proper response cannot be confirmed are as below:
- The signal transmission speed settings do not match.
 - The transmission cable, or the connector, is not properly connected.

Caution

If the command result cannot be received even after the standby period has ended, it may be because the Album file is broken. In such a case, a process to restore the backup files will be executed and may take up to 2 minutes. Note that the Album file may be broken due to turning the Device OFF or resetting it while writing data on the Album.

- ④ Send the command to the Device.
 This is, for example, the process described in **3.3 Detection Process Flow** or **3.4 Registration Process Flow**. Specify the required commands in accordance with the application on the Host side.
Execute the "Set UART forwarding speed" first if connecting through UART.
- ⑤ Receive the command results from the Device.
 Confirm the response code received and proceed with the appropriate error processing should any error occur, in accordance with the application on the Host side.
- ⑥ Refer to **5.2 Additional Notes on Command Timeout** and **5.3 Command Timeout Calculation** for details on the commands' timeout period.
- ⑦ Send the command again if it was not properly received. Choose an appropriate number of tries (N) in accordance with the application on the Host side.
- ⑧ Proceed with the appropriate exception processing if the command result cannot be received after N number of tries. For example,
- Reset the Device.
 - Restart the system.

3.3 Detection Process Flow

This is the standard process flow for the detection process (when every command resulted in a normal end) executed on the Host side.

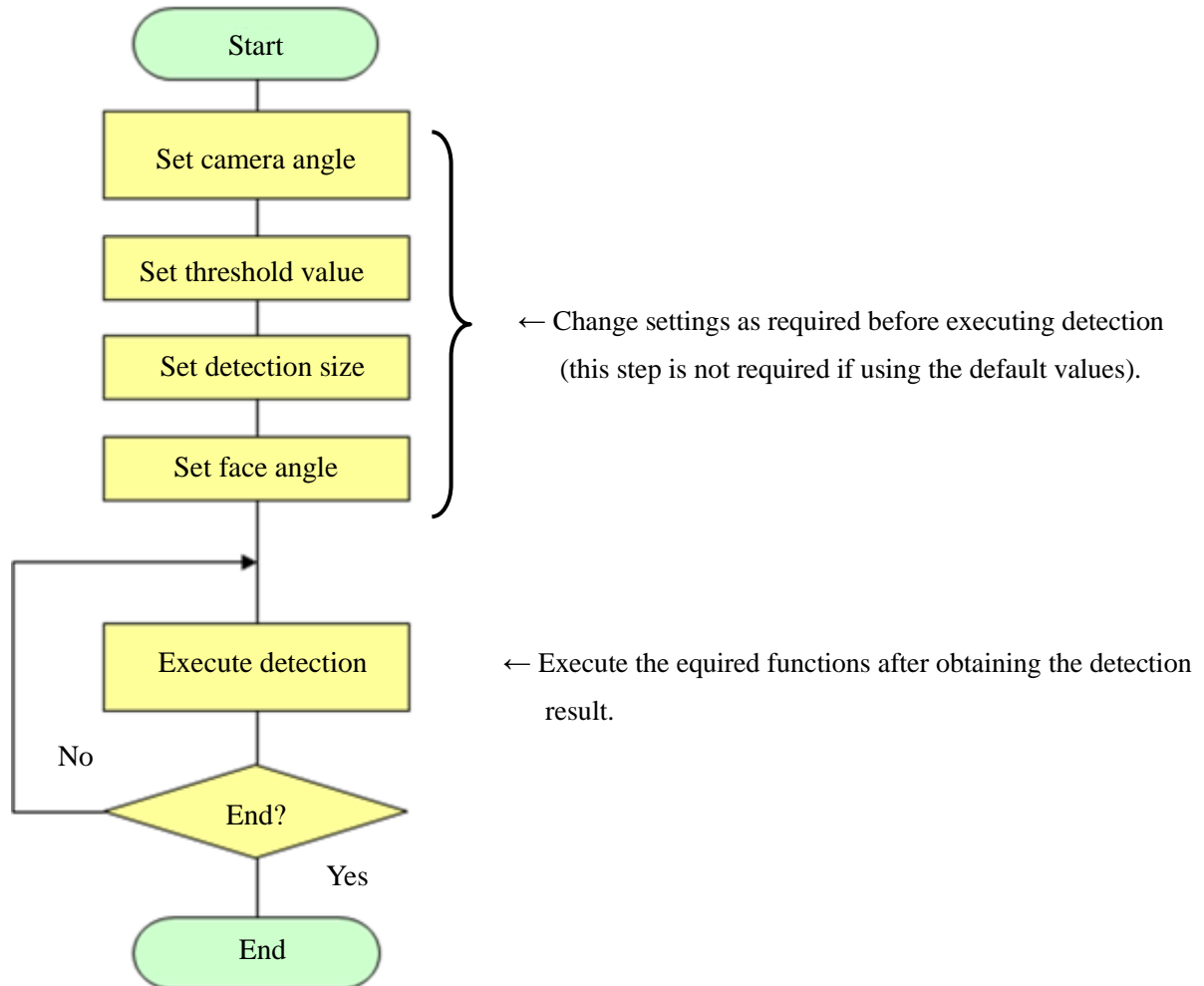

3.4 Registration Process Flow

This is the standard process flow for the data registration process for Face Recognition (when every command resulted in a normal end) executed on the Host side.

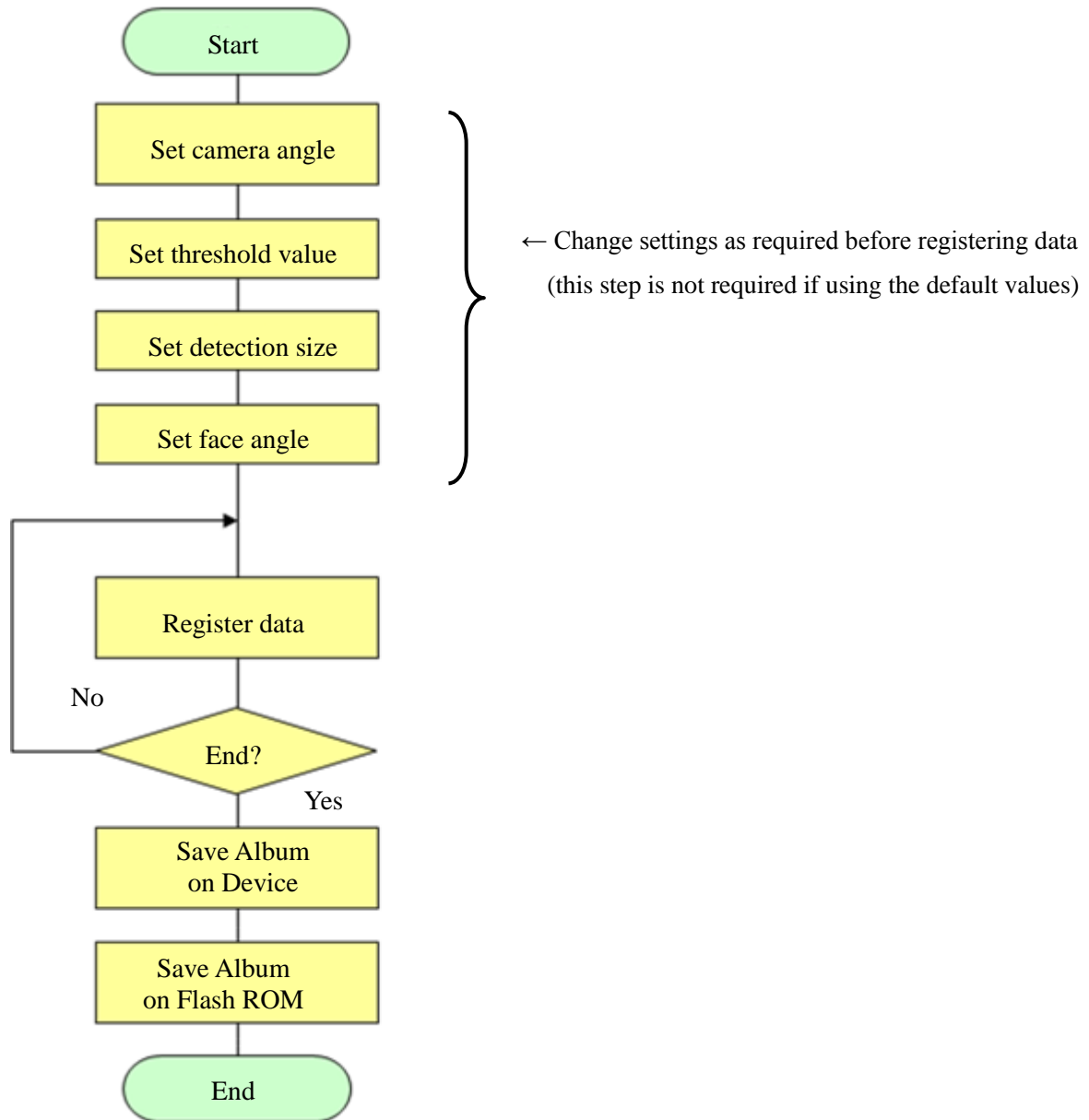

3.5 End Process Flow

Terminate the process of the Device before sending a command or just after receiving the results of a command execution.

Make sure not to terminate the Device process while executing the “**4.3.18 Save Album on Flash ROM**” command as the Album data is being written on the flash ROM during that time.

4 Command Specifications

4.1 Formats

4.1.1 Command Format

Synchronous code	Command number	Data length 2 bytes		Data
		LSB	MSB	
FEh	See 4.2 Command List	See 4.3 Command Description		

LSB: least significant byte

MSB: most significant byte

Note that the LSB will be transmitted first.

For example, for a data length of 300(012Ch) bytes, the transmission order will be 2Ch → 01h.

4.1.2 Response Format

Synchronous code	Response code	Data length 4 bytes				Data
		L-LSB	L-MSB	H-LSB	H-MSB	
FEh	See 4.4 Response Code List	See 4.3 Command Description				

L-LSB: least significant byte (low word)

L-MSB: most significant byte (low word)

H-LSB: least significant byte (high word)

H-MSB: most significant byte (high word)

Note that the L-LSB will be transmitted first.

For example, for a data length of 76816(00012C10h) bytes, the transmission order will be 10h → 2Ch → 01h → 00h.

4.2 Command List

Command number	Command name	Command description
00h	Get model and version	Gets the Device's model and version.
01h	Set camera angle	Sets the camera angle.
02h	Get camera angle	Gets the camera angle set.
04h	Execute detection	Executes the specified functions, e.g. Face Detection , Blink Estimation , etc.
05h	Set threshold value	Sets the threshold values for Human Body Detection , Hand Detection , Face Detection and/or Face Recognition .
06h	Get threshold value	Gets the threshold value set for Human Body Detection , Hand Detection , Face Detection and/or Face Recognition .
07h	Set detection size	Sets the detection size for Human Body Detection , Hand Detection and/or Face Detection .
08h	Get detection size	Gets the detection size set for Human Body Detection , Hand Detection and/or Face Detection .
09h	Set face angle	Sets the face angle, i.e. the yaw angle range and the roll angle range for Face Detection .
0Ah	Get face angle	Gets the face angle set for Face Detection .
0Eh	Set UART forwarding rate	Sets the UART forwarding rate.
10h	Register data	Registers data for Face Recognition and gets a normalized image.
11h	Delete specified data	Deletes a specified registered data.
12h	Delete specified user	Deletes a specified registered user.
13h	Delete all data	Deletes all the registered data.
15h	Get user info	Gets the registration info of a specified user.
20h	Save Album	Saves the Album on the Host side.
21h	Load Album	Loads the Album from the Host side to the Device.
22h	Save Album on Flash ROM	Saves the Album on the flash ROM
30h	Reformat Flash ROM	Reformats the Album save area on the flash ROM.

4.3 Command Description

4.3.1 Get Model and Version

This gets the model and version info of the Device.

■ Command (Host → Device)

Synchronous code	Command number	Data length	
FEh	00h	00h	00h

■ Response (Device → Host)

Synchronous code	Response code	Data length				Data
FEh	Normal end: 00h	13h	00h	00h	00h	See below for details
	Error: FFh to C0h	00h	00h	00h	00h	

Data

Model text (12 characters):	“B5T-007001 ”
Major version (1 byte HEX):	used for major changes
Minor version (1 byte HEX):	used for minor changes
Release version (1 byte HEX):	used for minor corrections
Revision number (4 byte HEX):	used internally

4.3.2 Set Camera Angle

This sets camera angle.

■ **Command (Host → Device)**

Synchronous code	Command number	Data length		Data
FEh	01h	01h	00h	See below for details

■ **Response (Device → Host)**

Synchronous code	Response code	Data length			
FEh	Normal end: 00h	00h	00h	00h	00h
	Error: FFh to C0h	00h	00h	00h	00h

Data

The camera angle is the angle used when facing the camera. The camera angle and the image orientation are as displayed below. Note that this manual refers to right and left from the perspective of looking at a picture, i.e. the left will be the actual right of the individual displayed, and vice-versa.

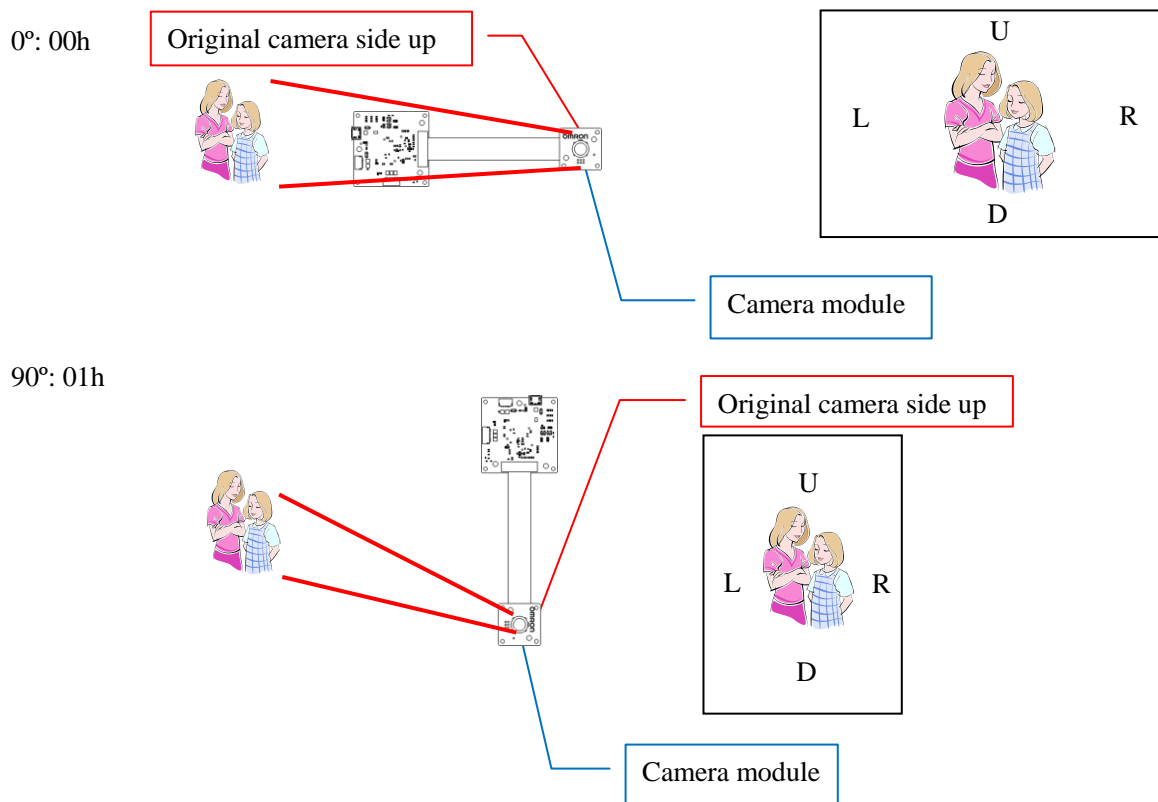

180°: 02h

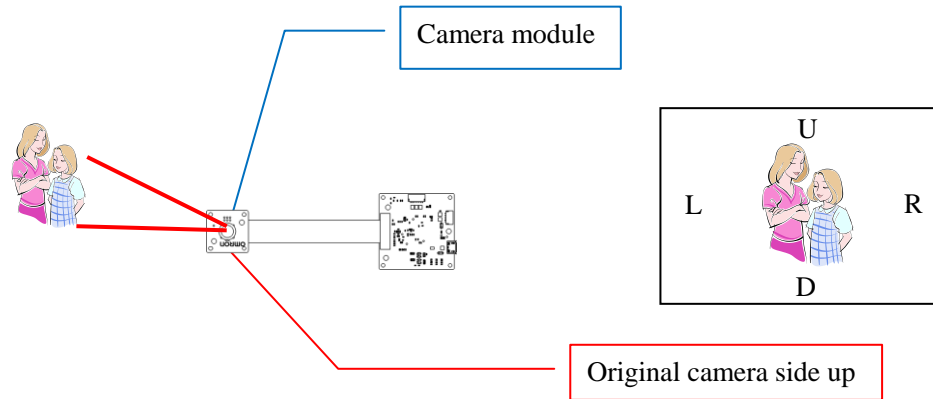

270°: 03h

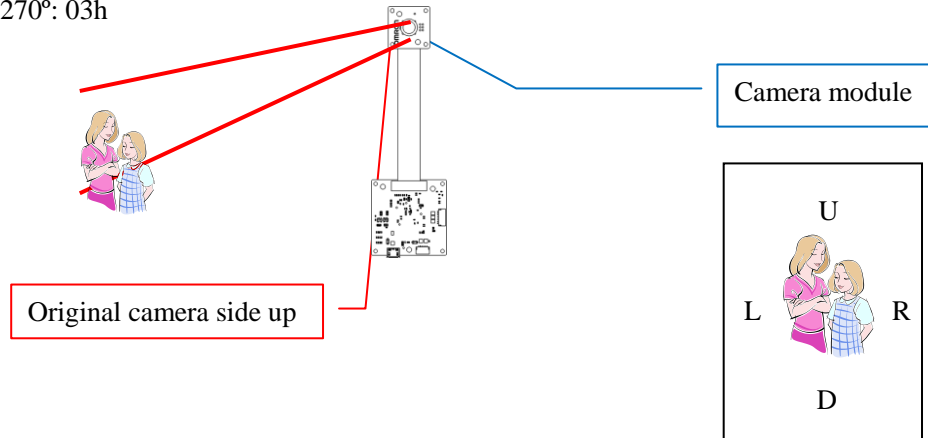

Note that "U" is for the up direction, "R" is for right direction, "D" is for the down direction and "L" is for the left direction.

4.3.3 Get Camera Angle

This gets the camera angle set.

■ **Command (Host → Device)**

Synchronous code	Command number	Data length	
FEh	02h	00h	00h

■ **Response (Device → Host)**

Synchronous code	Response code	Data length				Data
FEh	Normal end: 00h	01h	00h	00h	00h	See below for details
	Error: FFh to C0h	00h	00h	00h	00h	

Data

The camera angle is the angle used when facing the camera.

0°	00h
90°	01h
180°	02h
270°	03h

4.3.4 Execute detection

This executes the detection process and the specified functions. The shrunken image can be output when the detection process is executed.

■ Command (Host → Device)

Synchronous code	Command number	Data length		Data
FEh	04h	03h	00h	See below for details

■ Response (Device → Host)

Synchronous code	Response code	Data length				Data
FEh	Normal end: 00h	See the next pages for details				See the next pages for details
	Error: FFh to C0h	00h	00h	00h	00h	

Command Data

The function specification (2 bytes) and the image output designation (1 byte) are as displayed below.

The specification of the functions to be executed is done by specifying the bit data.

The functions with “1” specified will be executed.

First byte

Bit7	Bit6	Bit5	Bit4	Bit3	Bit2	Bit1	Bit0
Blink Estimation	Gaze Estimation	Gender Estimation	Age Estimation	Face Direction Estimation	Face Detection	Hand Detection	Human Body Detection

Second byte

Bit7	Bit6	Bit5	Bit4	Bit3	Bit2	Bit1	Bit0
0 fixed	0 fixed	0 fixed	0 fixed	0 fixed	0 fixed	Face Recognition	Expression Estimation

Third byte

00h : no image output
01h : image output in 320×240 pixel resolution (QVGA)
02h : image output in 160×120 pixel resolution

Notes

*NOTE 1: The image can be output even if no function is specified (all “0”) for execution.

*NOTE 2: No error will occur if nothing is specified, including the output result setting.

Result info

The result info can be broadly divided as displayed below.

Data				
Header	Human Body Detection result	Hand Detection result	Face Detection related results	Image data
4 bytes	$8 \times n$ bytes	$8 \times n$ bytes	$(2 \text{ to } 38) \times n$ bytes	0/19204/76804 bytes

Face Detection related results							
Face Detection result	Face Direction Estimation result	Age Estimation result	Gender Estimation result	Gaze Estimation result	Blink Estimation result	Expression Estimation result	Face Recognition result
8 bytes	8 bytes	3 bytes	3 bytes	2 bytes	4 bytes	6 bytes	4 bytes

*NOTE 1: The detection result will not be output when the detection process is not executed. Likewise, the image data will not be output when the image is not output (both will become 0 byte).

The data format will all be signed (signed char, signed short, signed int), except for the luminance value of the image data (not signed).

The “n” value will range from 0 to 35 (maximum number of detected items).

Data length range

The data length is from 4 (minimum value) to 78698(0001336Ah) bytes.

The maximum values for the data are as displayed below.

Data				
Header	Human Body Detection result	Hand Detection result	Face Detection related result	Image data
4 bytes	8×35 bytes	8×35 bytes	38×35 bytes	76804 bytes

Header

The header displays the following information.

Header			
Number of detected human bodies	Number of detected hands	Number of detected faces	Reserved
0 to 35	0 to 35	0 to 35	0 fixed

Human Body Detection

Human Body Detection result 8 bytes × number of detected human bodies							
x-coordinate		y-coordinate		Size		Degree of confidence (0 to 1000)	
LSB	MSB	LSB	MSB	LSB	MSB	LSB	MSB

The point of origin for the coordinates is the top-left corner of the image.

The image is in 1600×1200 (or 1200×1600) pixels.

The coordinates for **Human Body Detection** are the x and y coordinates of the center point of the detected human body.

Hand Detection

Hand Detection result 8 bytes × number of detected hands							
x-coordinate		y-coordinate		Size		Degree of confidence (0 to 1000)	
LSB	MSB	LSB	MSB	LSB	MSB	LSB	MSB

The coordinates for **Hand Detection** are the x and y coordinates of the center point of the detected hand.

Face Detection

Face Detection result 8 bytes							
x-coordinate		y-coordinate		Size		Degree of confidence (0 to 1000)	
LSB	MSB	LSB	MSB	LSB	MSB	LSB	MSB

The coordinates for **Face Detection** are the x and y coordinates of the center point of the detected face.

Face Direction Estimation

Face Direction Estimation result							
8 bytes							
Yaw angle (left-right) (-180 to 179)		Pitch angle (up-down) (-180 to 179)		Roll angle (-180 to 179)		Degree of confidence (0 to 1000)	
LSB	MSB	LSB	MSB	LSB	MSB	LSB	MSB

For the yaw angle, a left direction will have a negative value while a right direction will have a positive value.

For the pitch angle, a down direction will have a negative value while an up direction will have a positive value.

For the roll angle, a counter-clockwise inclination will have a negative value while a clockwise inclination will have a positive value.

Age Estimation

Age Estimation result			
3 bytes			
All values will be -128(80h, FF80h) when the estimation was not possible LSB = 80h, MSB = FFh			
Age (0 to 75)		Degree of confidence (0 to 1000)	
*NOTE 2		LSB	MSB

*NOTE 2: The value 75 includes higher ages too.

Gender Estimation

Gender Estimation result			
3 bytes			
All values will be -128(80h, FF80h) when the estimation was not possible. LSB = 80h, MSB = FFh			
Gender (0 or 1)		Degree of confidence (0 to 1000)	
0: Female 1: Male		LSB	MSB

Gaze Estimation

Gaze Estimation result			
2 bytes			
All values will be -128(80h) when the estimation was not possible.			
Yaw angle (left-right) (-90 to 90)		Pitch angle (Up-down) (-90 to 90)	

For the yaw angle, a left direction will have a negative value while a right direction will have a positive value.

For the pitch angle, a down direction will have a negative value while an up direction will have a positive value.

Blink Estimation

Blink Estimation result 4 bytes All values will be -128(FF80h) when the estimation was not possible LSB = 80h, MSB = FFh			
Blink degree (left) (1 to 1000)		Blink degree (right) (1 to 1000)	
LSB	MSB	LSB	MSB

A higher value indicates the eye is closer to being fully shut (1000).

Expression Estimation

Expression Estimation result 6 bytes All values will be -128(80h) when the estimation was not possible					
Neutral (0 to 100)	Happiness (0 to 100)	Surprise (0 to 100)	Anger (0 to 100)	Sadness (0 to 100)	Expression degree (positive/negative) (-100 to 100)

A higher value of happiness will result in an expression degree closer to +100, while higher values of surprise, anger and sadness will result in an expression degree closer to -100.

Face Recognition

Face Recognition result 4 bytes All values will be -128(FF80h) when the recognition was not possible LSB = 80h, MSB = FFh All the values will be -127(FF81h) when no data is registered in the Album LSB = 81h, MSB = FFh			
User ID (0 to 99) FFFFh: no corresponding ID		Score (degree of likeliness) (0 to 1000) * NOTE 3	
LSB	MSB	LSB	MSB

*NOTE 3: The top score will still be output when the User ID is FFFFh, indicating a score lower than the threshold value set.

Image data

Image data 76804/19204 bytes				
Width (320 / 160)		Height (240 / 120)		Greyscale value of each pixel (luminance value) 0 to 255(FFh)
LSB	MSB	LSB	MSB	

*NOTE 4: The width and height will be reversed when the camera angle is set to 90° or 270°.

With “W” as the width and “H” as the height of the image data, the pixel data output order will be as displayed below.

	Data name
1	Greyscale value of (0,0) (luminance)
2	Greyscale value of (1,0) (luminance)
3	Greyscale value of (2,0) (luminance)
...	...
W	Greyscale value of (W-1,0) (luminance)
W+1	Greyscale value of (0,1) (luminance)
...	...
W×H-1	Greyscale value of (W-2,H-1) (luminance)
W×H	Greyscale value of (W-1,H-1) (luminance)

Result info example

The data aligned in the header will be as displayed below when 35 items were detected for each category (human body, hand and face).

Human Body Detection result	Hand Detection result	Face Detection related result
8 × 35 bytes	8 × 35 bytes	(2 to 35) × 35 bytes

When **Human Body Detection**, **Face Detection** and **Age Estimation** are specified, the result will be as displayed below when 2 human bodies and 2 faces are detected.

Human Body Detection result 1	Human Body Detection result 2	Face Detection related result 1		Face Detection related result 2	
		Face Detection	Age Estimation	Face Detection	Age Estimation
8 bytes	8 bytes	8+3 bytes		8+3 bytes	

When **Age Estimation** and **Gender Estimation** are specified, the result will be as displayed below when 2 faces are detected.

Face Detection related result 1		Face Detection related result 2	
Age Estimation	Gender Estimation	Age Estimation	Gender Estimation
3+3 bytes		3+3 bytes	

When there are multiple detected items, the position of the face will be unknown if **Face Detection** was not selected. As such, it is recommended to specify **Face Detection** for execution. Note that **Face Detection** will be executed even if it was not selected when selecting **Age Estimation** or any other **Face Detection** related function.

4.3.5 Set Threshold Values

This sets the threshold values for **Human Body Detection**, **Hand Detection**, **Face Detection** and/or **Face Recognition**.

■ Command (Host → Device)

Synchronous code	Command number	Data length		Data
FEh	05h	08h	00h	See below for details

■ Response (Device → Host)

Synchronous code	Response code	Data length			
FEh	Normal end: 00h	00h	00h	00h	00h
	Error: FFh to C0h	00h	00h	00h	00h

Data

The specification range for the threshold value (2 bytes) of **Human Body Detection**, **Hand Detection**, **Face Detection** and **Face Recognition** is as displayed below.

Face Recognition: 0 to 1000

Others: 1 to 1000

The table below displays the values when set for a threshold value of 500.

#	Data name	Value when set for 500
1	Threshold value for Human Body Detection (LSB)	F4h
2	Threshold value for Human Body Detection (MSB)	01h
3	Threshold value for Hand Detection (LSB)	F4h
4	Threshold value for Hand Detection (MSB)	01h
5	Threshold value for Face Detection (LSB)	F4h
6	Threshold value for Face Detection (MSB)	01h
7	Threshold value for Face Recognition (LSB)	F4h
8	Threshold value for Face Recognition (MSB)	01h

Notes

The default value for all the threshold values is 500.

4.3.6 Get Threshold Values

This gets the threshold values set.

Command (Host → Device)

Synchronous code	Command number	Data length	
FEh	06h	00h	00h

■ Response (Device → Host)

Synchronous code	Response code	Data length				Data
FEh	Normal end: 00h	08h	00h	00h	00h	See below for details
	Error: FFh to C0h	00h	00h	00h	00h	

Data

The threshold values for **Human Body Detection**, **Hand Detection**, **Face Detection** and **Face Recognition** (2 bytes each) are as displayed below.

#	Data name
1	Threshold value for Human Body Detection (LSB)
2	Threshold value for Human Body Detection (MSB)
3	Threshold value for Hand Detection (LSB)
4	Threshold value for Hand Detection (MSB)
5	Threshold value for Face Detection (LSB)
6	Threshold value for Face Detection (MSB)
7	Threshold value for Face Recognition (LSB)
8	Threshold value for Face Recognition (MSB)

4.3.7 Set Detection Size

This sets the detection sizes for **Human Body Detection**, **Hand Detection** and **Face Detection**.

Command (Host → Device)

Synchronous code	Command number	Data length		Data
FEh	07h	0Ch	00h	See below for details

■ Response (Device → Host)

Synchronous code	Response code	Data length			
FEh	Normal end: 00h	00h	00h	00h	00h
	Error: FFh to C0h	00h	00h	00h	00h

Data

The specification range for the minimum and maximum detection size (2 bytes each) of **Human Body Detection**, **Hand Detection**, **Face Detection** and **Face Recognition** is from 20 to 8192, with a required maximum value larger than or equal to the minimum value.

The table below displays the values when set for a minimum detection size of 50 and a maximum detection size of 500.

#	Data name	Value when set to 50/500
1	Minimum detection size for Human Body Detection (LSB)	32h
2	Minimum detection size for Human Body Detection (MSB)	00h
3	Maximum detection size for Human Body Detection (LSB)	F4h
4	Maximum detection size for Human Body Detection (MSB)	01h
5	Minimum detection size for Hand Detection (LSB)	32h
6	Minimum detection size for Hand Detection (MSB)	00h
7	Maximum detection size for Hand Detection (LSB)	F4h
8	Maximum detection size for Hand Detection (MSB)	01h
9	Minimum detection size for Face Detection (LSB)	32h
10	Minimum detection size for Face Detection (MSB)	00h
11	Maximum detection size for Face Detection (LSB)	F4h
12	Maximum detection size for Face Detection (MSB)	01h

Notes

The minimum and maximum default values are 30/8192 for **Human Body Detection**, 40/8192 for **Hand Detection** and 64/8192 for **Face Detection**.

4.3.8 Get Detection Size

This gets the detection sizes set.

Command (Host → Device)

Synchronous code	Command number	Data length	
FEh	08h	00h	00h

■ Response (Device → Host)

Synchronous code	Response code	Data length				Data
FEh	Normal end: 00h	0Ch	00h	00h	00h	See below for details
	Error: FFh to C0h	00h	00h	00h	00h	

Data

The minimum and maximum detections sizes for **Human Body Detection**, **Hand Detection** and **Face Detection** (2 bytes each) are as displayed below.

#	Data name
1	Minimum detection size for Human Body Detection (LSB)
2	Minimum detection size for Human Body Detection (MSB)
3	Maximum detection size for Human Body Detection (LSB)
4	Maximum detection size for Human Body Detection (MSB)
5	Minimum detection size for Hand Detection (LSB)
6	Minimum detection size for Hand Detection (MSB)
7	Maximum detection size for Hand Detection (LSB)
8	Maximum detection size for Hand Detection (MSB)
9	Minimum detection size for Face Detection (LSB)
10	Minimum detection size for Face Detection (MSB)
11	Maximum detection size for Face Detection (LSB)
12	Maximum detection size for Face Detection (MSB)

4.3.9 Set Face Angle

This sets the face angle for **Face Detection**, i.e. the yaw and roll angle range to be detected.

■ Command (Host → Device)

Synchronous code	Command number	Data length		Data
FEh	09h	02h	00h	See below for details

■ Response (Device → Host)

Synchronous code	Response code	Data length			
FEh	Normal end: 00h	00h	00h	00h	00h
	Error: FFh to C0h	00h	00h	00h	00h

Data

The face direction yaw angle range and face inclination roll angle range (1 byte each) are as displayed below.

First byte

Yaw angle range 00h : $\pm 30^\circ$ (frontal face) (#3) 01h : $\pm 60^\circ$ (half-profile face) (#2 & #4) 02h : $\pm 90^\circ$ (profile face) (#1 & #5)
--

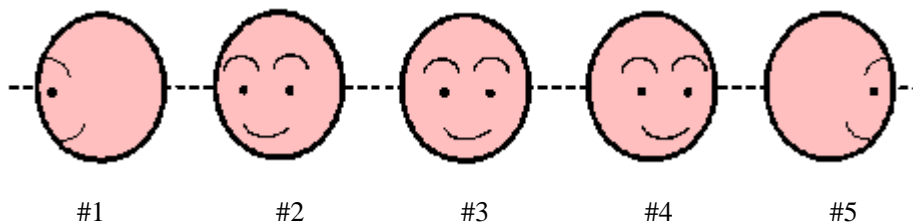

Second byte

Roll angle range 00h : $\pm 15^\circ$ 01h : $\pm 45^\circ$
--

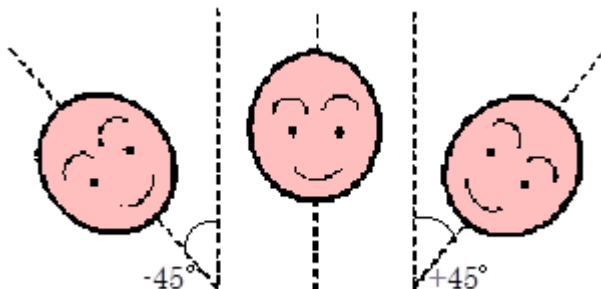

Notes

The default values are $\pm 30^\circ$ for the yaw angle range and $\pm 15^\circ$ for the roll angle range.

4.3.10 Get Face Angle

This gets the face angle set for **Face Detection**.

■ Command (Host → Device)

Synchronous code	Command number	Data length	
FEh	0Ah	00h	00h

■ Response (Device → Host)

Synchronous code	Response code	Data length				Data
FEh	Normal end: 00h	02h	00h	00h	00h	See below for details
	Error: FFh to C0h	00h	00h	00h	00h	

Data

The face direction yaw angle range and face inclination roll angle range (each 1 byte) are as displayed below.

First byte

Yaw angle range 00h: ±30° 01h: ±60° 02h: ±90°
--

Second byte

Roll angle range 00h: ±15° 01h: ±45°
--

4.3.11 Set UART Forwarding Rate

This sets the UART forwarding rate (in bps).

The setting can be done when the USB is connected and will have no influence on the transmission speed as this is a command for the UART connection.

■ Command (Host → Device)

Synchronous code	Command number	Data length		Data
FEh	0Eh	01h	00h	See below

■ Response (Device → Host)

Synchronous code	Response code	Data length			
FEh	Normal end: 00h	00h	00h	00h	00h
	Error: FFh to C0h	00h	00h	00h	00h

Data

#	Forwarding rate (bps)	Set value
1	9600	00h
2	38400	01h
3	115200	02h
4	230400	03h
5	460800	04h
6	921600	05h

The default forwarding rate is 9600 bps.

4.3.12 Register Data (Face Recognition)

This registers face recognition data on the Device to be used for **Face Recognition**.

Note that any already registered data will be overwritten.

Command (Host → Device)

Synchronous code	Command number	Data length		Data
FEh	10h	03h	00h	See below for details

■ Response (Device → Host)

Synchronous code	Response code	Data length				Data
FEh	Normal end: 00h	04h	10h	00h	00h	Image data (face) See below for details
	Error: 01h, 02h, FFh to C0h	00h	00h	00h	00h	

Command Data

The User ID (2 bytes) and Data ID (1 byte) are as displayed below.

The specification range is 0 to 99 for the User ID and 0 to 9 for the Data ID.

The set values when the User ID is 50 and the Data ID is 5 are displayed below.

	Data name	Set value for example
1	User ID (LSB)	32h
2	User ID (MSB)	00h
3	Data ID	05h

Image Data

The image info (width and height, 2 bytes each) and image data are as displayed below.

The image data is in 64×64 pixels.

Note that the recognition data registered on the Device is not image data.

	Data name
1	Image width (LSB) (40h)
2	Image width (MSB) (00h)
3	Image height (LSB) (40h)
4	Image height (MSB) (00h)
5	Greyscale value of (0,0) (luminance)
6	Greyscale value of (1,0) (luminance)
7	Greyscale value of (2,0) (luminance)
...	...
4100	Greyscale value of (63,63) (luminance)

4.3.13 Delete Specified Data (Face Recognition)

This deletes a specified registered data from the Device.

■ Command (Host → Device)

Synchronous code	Command number	Data length		Data
FEh	11h	03h	00h	See below for details

■ Response (Device → Host)

Synchronous code	Response code	Data length			
FEh	Normal end: 00h	00h	00h	00h	00h
	Error: FFh to C0h	00h	00h	00h	00h

Data

The User ID (2 bytes) and Data ID (1 byte) are as displayed below.

The specification range is 0 to 99 for the User ID and 0 to 9 for the Data ID.

The set values when the User ID is 50 and the Data ID is 5 are displayed below.

	Data name	Set value for example
1	User ID (LSB)	32h
2	User ID (MSB)	00h
3	Data ID	05h

4.3.14 Delete Specified User (Face Recognition)

This deletes all the registered data of a specified user from the Device.

■ Command (Host → Device)

Synchronous code	Command number	Data length		Data
FEh	12h	02h	00h	See below for details

■ Response (Device → Host)

Synchronous code	Response code	Data length			
FEh	Normal end: 00h	00h	00h	00h	00h
	Error: FFh to C0h	00h	00h	00h	00h

Data

The User ID (2 bytes) is as displayed below.

The specification range is 0 to 99 for the User ID.

The set values when the User ID is 50 are displayed below.

	Data name	Set value for example
1	User ID (LSB)	32h
2	User ID (MSB)	00h

4.3.15 Delete All Data (Face Recognition)

This deletes all the registered from the Device.

■ Command (Host → Device)

Synchronous code	Command number	Data length	
FEh	13h	00h	00h

■ Response (Device → Host)

Synchronous code	Response code	Data length			
FEh	Normal end: 00h	00h	00h	00h	00h
	Error: FFh to C0h	00h	00h	00h	00h

4.3.16 Get Registration Info (Face Recognition)

This gets the registration info, i.e. the presence or absence of registered data, for the specified user.

■ Command (Host → Device)

Synchronous code	Command number	Data length		Data
FEh	15h	02h	00h	See below for details

■ Response (Device → Host)

Synchronous code	Response code	Data length				Data
FEh	Normal end: 00h	02h	00h	00h	00h	Registration info See below for details
	Error: FFh to C0h	00h	00h	00h	00h	

Data

The User ID (2 bytes) is as displayed below.

The specification range is 0 to 99 for the User ID.

The set values when the User ID is 50 are displayed below.

	Data name	Set value for example
1	User ID (LSB)	32h
2	User ID (MSB)	00h

Registration Info

The registration info for the specified User ID is displayed in bit data. A value of “1” for a specified User ID indicates that there is data registered for that specified user.

First byte

Bit7	Bit6	Bit5	Bit4	Bit3	Bit2	Bit1	Bit0
ID7	ID6	ID5	ID4	ID3	ID2	ID1	ID0

Second byte

Bit7	Bit6	Bit5	Bit4	Bit3	Bit2	Bit1	Bit0
0	0	0	0	0	0	ID9	ID8

The values will be FFh and 03h when all users have registered data.

Values of 6Eh and 00h indicate that ID1 to ID3, ID5, and ID6 have registered data.

4.3.17 Save Album (Face Recognition)

This saves the Album on the Host side. Album data already present will be overwritten.

■ Command (Host → Device)

Synchronous code	Command number	Data length	
FEh	20h	00h	00h

■ Response (Device → Host)

Synchronous code	Response code	Data length				Data
FEh	Normal end: 00h	28h,00,00,00, to A8h,7Dh,02h,00h				Album See below for details
	Error: FFh to C0h	00h	00h	00h	00h	

Album

The Album size (4 bytes), CRC (4 bytes) and Album data (32 to 163,232 bytes) are as displayed below.

	Data name
1	Album size (LSB0)
2	Album size (LSB1)
3	Album size (MSB0)
4	Album size (MSB1)
5	CRC (LSB0)
6	CRC (LSB1)
7	CRC (MSB0)
8	CRC (MSB1)
9	Album data
...	...
163,240	Album data

4.3.18 Load Album (Face Recognition)

This loads the Album from the Host side onto the Device. Album data already present will be overwritten.

Note that this command has different specifications from the others. The “Data length” specification indicates the transmission size of the data field.

■ Command (Host → Device)

Synchronous code	Command number	Data length		Data
FEh	21h	04h	00h	Album See below for details

■ Response (Device → Host)

Synchronous code	Response code	Data length			
FEh	Normal end: 00h	00h	00h	00h	00h
	Error: FFh to C0h	00h	00h	00h	00h

Album

The transmission size (4 bytes), Album size (4 bytes), CRC (4 bytes) and Album data (32 to 163,232 bytes) are as displayed below.

	Data name
1	Transmission size (LSB0)
2	Transmission size (LSB1)
3	Transmission size (MSB0)
4	Transmission size (MSB1)
5	Album size (LSB0)
6	Album size (LSB1)
7	Album size (MSB0)
8	Album size (MSB1)
9	CRC (LSB0)
10	CRC (LSB1)
11	CRC (MSB0)
12	CRC (MSB1)
13	Album data
...	...
163,244	Album data

4.3.19 Save Album in Flash ROM (Face Recognition)

This saves the Album on the flash ROM of the Device.

The processing time will be longer if there is a lot of data.

Album data already present on the flash ROM of the Device will be overwritten.

■ Command (Host → Device)

Synchronous code	Command number	Data length	
FEh	22h	00h	00h

■ Response (Device → Host)

Synchronous code	Response code	Data length			
FEh	Normal end: 00h	00h	00h	00h	00h
	Error: FFh to C0h	00h	00h	00h	00h

4.3.20 Reformat Flash ROM (Face Recognition)

This reformats the area storing the recognition data on the flash ROM of the Device.

■ Command (Host → Device)

Synchronous code	Command number	Data length	
FEh	30h	00h	00h

■ Response (Device → Host)

Synchronous code	Response code	Data length			
FEh	Normal end: 00h	00h	00h	00h	00h
	Error: FFh to C0h	00h	00h	00h	00h

4.4 Response Code List

Response code	Response contents
00h	Normal end
01h	Number of faces that can be registered is 0 (for Registration command only)
02h	Number of detected faces is 2 or more (for Registration command only)
FFh	Undefined error (this happens when an unlisted command is received)
FEh	Internal error
FDh	Improper command
FAh - FCh	Transmission error
F0h - F9h	Device error
C0h - DFh	Face Recognition data error

4.5 Additional Notes

4.5.1 Error message at startup

Should any error occur at Device startup, the appropriate error code will be sent as the response for the first command executed. In such a case, the first command received after the startup will not be executed.

4.5.2 Data deletion

After receiving the sync code (FEh), the Device will wait for a set time (around 100msec) before receiving each data of the number of data corresponding to the command specification.

All the previously received but incomplete data will be discarded when that set period of time has passed without receiving the remaining data. In such a case, the Device will go back to a data waiting status.

All the data received before receiving the sync code (FEh) will be discarded too.

5 Command Timeout

5.1 Definition of Command Timeout

The command timeout period is the amount of time set to wait to receive a synch code from the Device after a command has been sent from the Host side.

5.2 Additional Notes on Command Timeout

Consider the following when specifying the command timeout period.

1. The command used
2. The functions specified
3. The parameters set for **Face Detection**
(minimum detection size, face direction yaw angle, face inclination roll angle)
4. The number of users registered in the Album

5.3 Command Timeout Calculation

5.3.1 Command timeout for commands

Set values above the ones displayed below for on the timeout period on the Host side.

Command number	Command name	Command timeout period (seconds)
00h	Get model and version	1
01h	Set camera angle	1
02h	Get camera angle	1
04h	Execute detection	(*1)
05h	Set threshold value	1
06h	Get threshold value	1
07h	Set detection size	1
08h	Get detection size	1
09h	Set face angle	1
0Ah	Get face angle	1
0Eh	Set forwarding rate	1
10h	Register data	1
11h	Delete specified data	1
12h	Delete specified user	1
13h	Delete all data	1
15h	Get user info	1
20h	Save Album	(*2)
21h	Load Album	(*2)
22h	Save Album on flash ROM	(*3)
30h	Reformat flash ROM	10

(*1) This depends on the functions specified, the parameters set for **Face Detection** and the number of users registered in the Album. Refer to **5.3.2 Command timeout for function commands** for details.

(*2) For UART, this depends on the transmission speed (bps). Refer to **5.3.3 Command timeout for Save/Load Album** for details.

(*3) This depends on the number of data registered in the Album. Refer to **5.3.4 Command timeout for Save Album on flash ROM** for details.

5.3.2 Command timeout for function commands

The command timeout period of the detection function is the sum of the individual timeout period required by each specified function, i.e. **Human Body Detection, Hand Detection, Face Detection, Face Direction Estimation, Age Estimation, Gender Estimation, Gaze Estimation, Blink Estimation, Expression Estimation** and **Face Recognition**.

Calculate the command timeout period by adding up the individual values for all the specified functions.

(*1) Function Timeout Period

Function	Command timeout period (seconds)
Human Body Detection	5
Hand Detection	5
Face Detection	Refer to (*2)
Face Direction Estimation	1
Age Estimation	1
Gender Estimation	1
Gaze Estimation	1
Blink Estimation	1
Expression Estimation	1
Face Recognition	Refer to (*3)

Make sure to add the command timeout period required for **Face Detection** when selecting **Face Direction Estimation**, even if the former is not specified.

Make sure to add the command timeout period required for **Face Detection** and **Face Direction Estimation** when selecting **Age Estimation, Gender Estimation, Gaze Estimation, Blink Estimation, Expression Estimation** and **Face Recognition**, even if the former are not specified.

(*2) Face Detection Timeout Period

Select the corresponding value depending on the parameters (minimum detection size, face inclination and face direction yaw angle) set.

Minimum detection size	Face inclination	Command timeout period (seconds)		
		Face direction yaw angle		
		$\pm 30^\circ$	$\pm 60^\circ$	$\pm 90^\circ$
Over 64	$\pm 15^\circ$	1	1	2
	$\pm 45^\circ$	1	2	3
20 to 63	$\pm 15^\circ$	3	6	10
	$\pm 45^\circ$	5	10	15

(*3) Face Recognition Timeout Period

Select the corresponding value depending on the number of users registered in the Album.

Number of users registered in the Album.	Command timeout period (seconds)
0 to 100	3

The command timeout period for the function commands is set for the maximum result count (35).

The command timeout period for the function commands will vary depending on the image data.

The values above are to be used as an indication only. Set the command timeout period in accordance with the

application used on the Host side.

5.3.3 Command timeout for Save/Load Album

The command timeout period for the Save and Load Album commands can be set to 1 second regardless of the transmission speed. However, the transmission time will depend on the transmission speed, as indicated below. The table below indicates the transmission time for the maximum recognition data stored in the Album, i.e. 100 users with 10 images per user.

Transmission speed (bps)	Command timeout period (seconds)	Transmission time (seconds)
9,600	1	250
38,400	1	50
115,200	1	20
230,400	1	15
460,800	1	10
921,600	1	5

5.3.4 Command timeout for Save Album on flash ROM

Select the corresponding value depending on the number of data registered in the Album.

Data registered in the Album	Command timeout period (seconds)
0 to 50	1
50 to 500	3
500 to 1000	5

6 Troubleshooting

6.1 Procedure Errors

The Device won't power-up (the LED is not lit)

Suspected cause	The cable connected to the Device is disconnected or missing
-----------------	--

Items to verify

Verify the connection of the cable and the connector.

Transmission is not possible just after powering-up the Device

Suspected cause	<ol style="list-style-type: none"> 1. The cable connected to the Device is disconnected or missing 2. The transmission setting with the Device is incorrect 3. The process for recovering the Album files is still running
-----------------	---

Items to verify

1. Verify the connection of the cable. The Device is not turned ON if the LED is not lit.
2. Verify the transmission settings of the Device on the Host side.
3. Wait 2 minutes before transmitting.

Face Detection or Face Recognition is not successful

Suspected cause	<ol style="list-style-type: none"> 1. The detection size and/or the threshold value settings are incorrect 2. The settings for the functions to be executed are incorrect 3. The Device's mounting orientation and the camera angle setting are incorrect 4. The camera is blocked 5. The protective seal of the camera lens is still attached to it
-----------------	---

Items to verify

1. Verify that the detection size and/or threshold value are not too high.
2. Verify that the appropriate functions are correctly selected.
3. Verify that the Device's mounting orientation and the camera angle setting match.
4. Verify that there are no obstacles in front of the camera.
5. Verify that the protective seal has been removed from the camera lens

The output image is not displayed

Suspected cause	<ol style="list-style-type: none"> 1. The transfer image size is set incorrectly 2. The camera is blocked
-----------------	---

Items to verify

1. Verify that the transfer image size is set to a value other than "no image".
2. Verify that there are no obstacles in front of the camera.

The output image is not clear

Suspected cause	The protective seal of the camera lens is still attached to it
-----------------	--

Items to verify

Verify that the protective seal has been removed from the camera lens.

The orientation of the output image is not right

Suspected cause	The camera angle setting is incorrect
-----------------	---------------------------------------

Items to verify

Verify the Device's mounting orientation and the camera angle setting.

The response is not returning

Suspected cause	The transmission data length is set incorrectly
-----------------	---

Items to verify

Verify that the transmission data length is set within the specification range.

6.2 Response Errors

Number of faces that can be registered is 0

Suspected cause	A face that can be registered was not successfully detected
-----------------	---

Solution

Verify the detection size and threshold value set for **Face Detection**.

Position the face within a yaw angle of $\pm 30^\circ$ and a pitch angle of $\pm 20^\circ$.

Distance the face from the camera when it is too close to it.

Move the face to the center of the camera screen when it is outside the image area.

Number of detected faces is 2 or more

Suspected cause	Multiple faces were detected
-----------------	------------------------------

Solution

Make sure to register the data for **Face Recognition** with only ONE face displayed.

Undefined command

Suspected cause	The command was not recognized
-----------------	--------------------------------

Solution

Verify the command number.

Internal error

Suspected cause	An internal error occurred
-----------------	----------------------------

Solution

Contact the HVC Customer Service.

Improper command

Suspected cause	The command data is improper
-----------------	------------------------------

Solution

Verify the command data.

Transmission error

Suspected cause	An error occurred while receiving the data
-----------------	--

Solution

Contact the HVC Customer Service.

Device error

Suspected cause	The hardware device malfunctioned
-----------------	-----------------------------------

Solution

Contact the HVC Customer Service.

Face Recognition data error

Suspected cause	The Album file used for Face Recognition or the file system info is broken
-----------------	---

Solution

Contact the HVC Customer Service.